

Applied Mathematics by Example: Theory

Jeremy Pickles

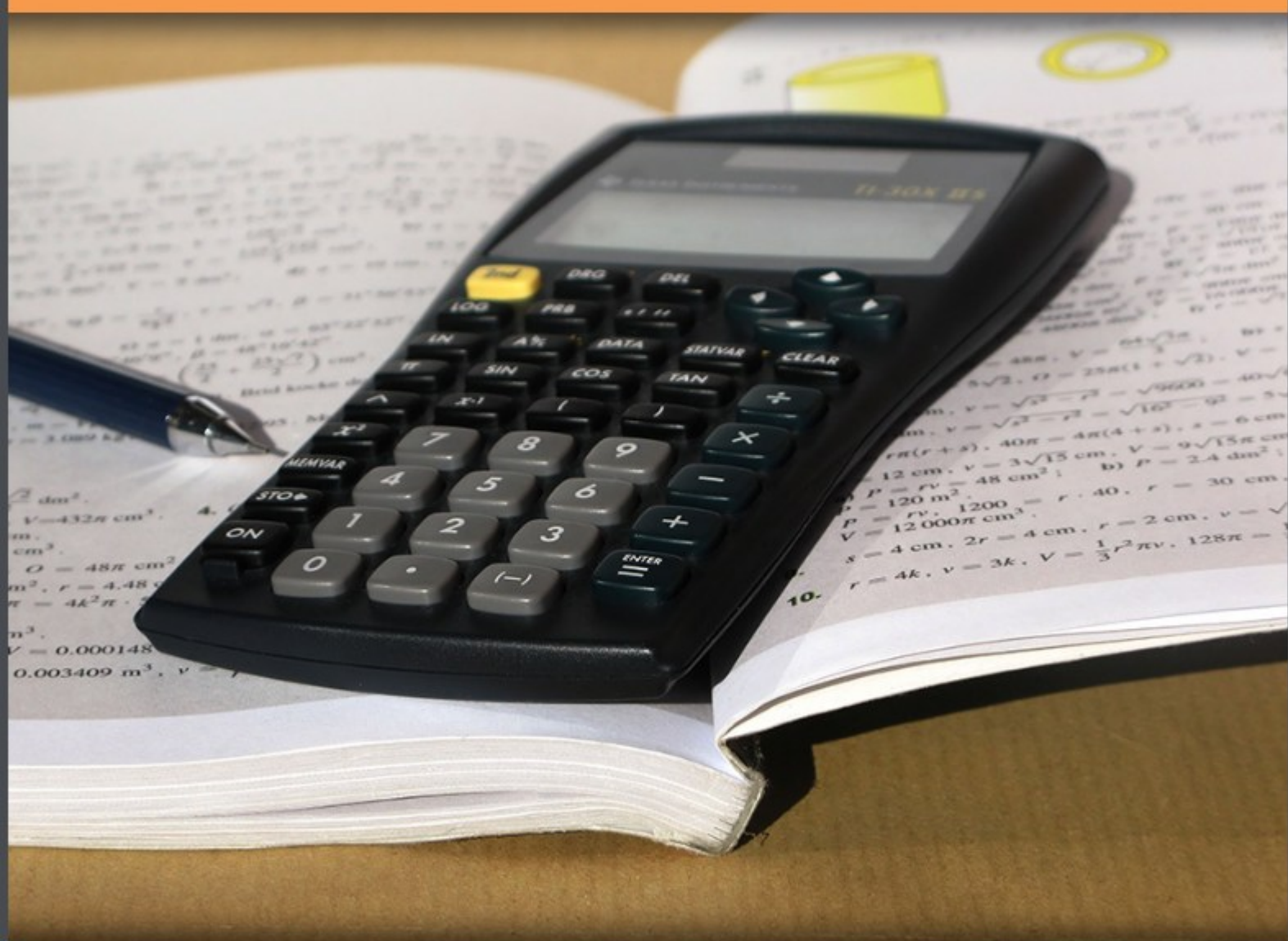

Download free books at

Jeremy Pickles

Applied Mathematics by Example: Theory

Applied Mathematics by Example: Theory
© 2010 Jeremy Pickles & Ventus Publishing ApS
ISBN 978-87-7681-624-7

Contents

	Preface	8
	Introduction by the Author	10
	About the Author	12
	Editor’s Note	14
	A note on symbols	15
1	Kinematics – motion in a straight line	16
1.1	Galileo and the acceleration due to gravity	16
1.2	Constant acceleration formulæ	17
1.3	Using the constant acceleration formulæ	19
1.4	Velocity-time graphs	22
1.5	Using a velocity-time graph	23
2	Projectiles	26
2.1	Separating horizontal and vertical motion	26
2.2	Components of velocity	29
2.3	Maximum range	30

Fast-track your career

Please click the advert

Masters in Management



London Business School
Regent's Park
London NW1 4SA
United Kingdom
Tel +44 (0)20 7000 7573
Email mim@london.edu
www.london.edu/mim/

Stand out from the crowd

Designed for graduates with less than one year of full-time postgraduate work experience, London Business School's Masters in Management will expand your thinking and provide you with the foundations for a successful career in business.

The programme is developed in consultation with recruiters to provide you with the key skills that top employers demand. Through 11 months of full-time study, you will gain the business knowledge and capabilities to increase your career choices and stand out from the crowd.

Applications are now open for entry in September 2011.

For more information visit www.london.edu/mim/
email mim@london.edu or call +44 (0)20 7000 7573

2.4	Equation of the trajectory	32
2.5	The envelope	34
3	Forces	36
3.1	Newton's laws	36
3.2	Identifying forces	37
3.3	Equilibrium	39
3.4	What is a body?	39
3.5	Connected particles	42
4	Resistance forces	45
4.1	Air resistance	45
4.2	Terminal velocity	46
4.3	Dynamic friction	48
4.4	Static friction	49
4.5	Rolling motion	53
5	Resolving forces	55
5.1	Vector addition	55
5.2	Components of a force	56
5.3	Resolution of forces	57
5.4	Resolving forces in two directions	61

Please click the advert



You're full of *energy*
and *ideas*. And that's
just what we are looking for.

Looking for a career where your ideas could really make a difference? UBS's Graduate Programme and internships are a chance for you to experience for yourself what it's like to be part of a global team that rewards your input and believes in succeeding together.

Wherever you are in your academic career, make your future a part of ours by visiting www.ubs.com/graduates.

www.ubs.com/graduates



© UBS 2010. All rights reserved.

6	Rigid bodies	63
6.1	Why rigid?	63
6.2	The lever	63
6.3	Rigid bodies in equilibrium	65
7	Centres of gravity	73
7.1	Using symmetry	73
7.2	Archimedes' calculations	73
7.3	Combining shapes	75
7.4	Hanging from a fixed point	76
7.5	Stability	79
8	Momentum	80
8.1	Momentum	80
8.2	Conservation of momentum	80
8.3	Collisions and explosions	81
8.4	Impulse	83
8.5	Duration of impact	85
8.6	Coecient of restitution	86
8.7	Oblique impacts	89
9	Energy	92
9.1	Potential energy and kinetic energy	92
9.2	Conservation of mechanical energy	93

Please click the advert

It's only an opportunity if you act on it

IKEA.SE/STUDENT

Reduce Reuse Recycle

WORK WITH US

to gether ness

save water. Shower together

everyone deserves good design

IKEA

© Inter IKEA Systems B.V. 2009

9.3	The work-energy principle	95
9.4	Power	97
10	Circular motion	100
10.1	Centripetal acceleration	100
10.2	Motion in a horizontal circle	101
10.3	Motion in a vertical circle	105
10.4	The pendulum	107
11	Gravitation and planetary motion	112
11.1	The Copernican model	112
11.2	Kepler's first law	112
11.3	Kepler's second law	114
11.4	Kepler's third law	116
11.5	Newton's law of gravitation	117
A	The language of vectors	122
A.1	Vectors	122
A.2	Displacement vectors and vector addition	122
A.3	Position vectors	124
A.4	Vectors for velocity, momentum, acceleration, force	125
A.5	Unit vectors	129

Please click the advert

YOUR CHANCE TO CHANGE THE WORLD

Here at Ericsson we have a deep rooted belief that the innovations we make on a daily basis can have a profound effect on making the world a better place for people, business and society. Join us.

In Germany we are especially looking for graduates as Integration Engineers for

- Radio Access and IP Networks
- IMS and IPTV

We are looking forward to getting your application!
To apply and for all current job openings please visit our web page: www.ericsson.com/careers

ericsson.
com



ERICSSON

Download free ebooks at bookboon.com

Preface

In many respects Applied Mathematics by Example is an ideal text book. It combines a light-hearted approach, well-rounded explanations and plenty of practice opportunities. It makes an ideal companion for those students who are commencing a course in mechanics, either at school or for undergraduate courses in Maths, Engineering or Physics.

From the outset of his teaching career Jeremy Pickles felt that available material was far too dry and dull. His aim was to enliven the study of mechanics through interesting or even humorous examples together with full explanations of where the various principles and formulæ came from. He had the view that this book would serve as both an introduction to mechanics and an introduction to the historical development of the subject.

He begins his story with reference to the experiments of Galileo and the origin of the constant acceleration formulæ. Likewise each main principle is described in the historical context of its origin. Most of the mechanics required for an introductory course, such as that found in A-level maths, deals with discoveries and models put together in the 17th century by Galileo and Isaac Newton. By treating the subject in this way, through asking the same questions that these great scientists did, the reader is able to absorb the essential cause of the mathematics. The effect of this is to give weight and substance to the principles of mechanics. Just as when dealing with projectiles we seek to discover why the path of a cannon ball is a parabola (literally, *para* – near to, *bola* – a throw) so we should also seek to determine the cause of the very question and answer. Jeremy addresses these issues with alacrity.

He also had a definite end-target in mind when he put this material together. He asked himself the questions of: How was it proved that the moon stays in orbit around the earth? Why does it not fall down? What keeps it at a constant distance away from us? Who was first able to prove this? Through the text we are introduced to Newton's way of thinking – that there is a single system of law governing weights and orbits. Jeremy knew that by answering such questions the reader would be able to master most of the mechanics required in the M1 and M2 modules for A-level mathematics. Furthermore, the text provides a useful introduction to mechanics for undergraduates.

Mechanics itself is an endearing and very useful educational tool. It teaches the student to understand physical laws that are expressed in mathematical terms and to apply those principles in unfamiliar situations. It teaches how to work logically and provides an excellent training in problem-solving. By these means mathematics itself is shown as an essential tool for engineering and science. Jeremy's book does justice to the real nature of the subject.

During the last ten years of his life Jeremy worked as a part-time A level teacher in the department of which I was head. He was an excellent teacher at this level and was devoted to helping the students under his care. This book is written from experience of teaching mechanics, which in itself is an extremely useful background at a time when so many text books are put together by authors solely employed by publishing houses.

I sincerely hope that students of introductory mechanics will find this book a useful companion.

James Glover, 2006

Introduction by the Author

Mathematics is an exceptionally useful subject. In our technological society, it has applications in business, in computing, in engineering, in medicine and in many other disciplines too. Of all academic qualifications, A-level mathematics is the one reported to correlate most closely with an individual's level of income. These factors naturally add to the attractions of the subject, but there are also disadvantages.

A student who learns at school about the history of the Roman Empire or the novels of Jane Austen is not concerned about what use this knowledge will be in later life. Nor are their teachers or the exam boards who set the syllabus. The student will no doubt learn some skills, how to weigh evidence or how to present an argument, but the main aim is the broadening of horizons, the refinement of judgement and the enjoyment of the study in the here and now. By comparison, the syllabus for mathematics is more constrained by the need to master the methods and skills necessary for future applications and further study in more advanced courses.

This book approaches mathematics from the wider perspective enjoyed by less obviously practical studies. A particular aim is to make accessible to students Newton's vision of a single system of law governing the falling of an apple in the orchard and the orbital motion of the moon. With recent changes in the syllabus, this, the example par excellence perhaps of the modern scientific method, is available only to specialist 'Further Mathematicians' (less than 1% of the student population). Both Newton and the student population deserve better.

En route to gravitation, we address similar topics to those covered in an A-level syllabus in mechanics, but there is more concern with the history of the subject and the development of ideas. So far as is possible, the ideas are introduced with the vivid arguments and illustrations used by Newton, Archimedes and Galileo in their writings. While there is no avoiding the need for calculation, the surprise is how far we can get with how little seriously technical work.

A famous mathematician once said that the complete appreciation of mathematics requires an element of poetry, and it is true that mathematics can offer the same sort of inspiration. The poet sees the essence behind the daily experience, the universe in a grain of sand, and the mathematician sees the law working behind the parachute and the pendulum, the suspension bridge and the rolling motion of a wheel. To see the two together, the principle and the particular application, is very beautiful and enormously satisfying to the student.

The aim, then, is to offer in each of the different areas covered half a dozen or a dozen examples where the seam of mathematical principle rises close to the surface of everyday experience. Some topics belonging strictly to a more advanced level of study, such as oblique collisions, or the envelope of a trajectory, are included because of their familiarity to anyone who uses a garden hose or watches snooker on TV. They are, however, not an integral part of the development and readers may simply browse these or skip them altogether as they wish. Conversely, less attention is paid to formal vector methods. These are introduced in an appendix and used in the main text only to support Newton's intuitive demonstration of the " v^2/r " centripetal acceleration formula. Elsewhere, we stick with the common-sense arguments with which Newton and Galileo first explored the study of forces and velocities. One of the unsung attractions of mechanics as a subject is that it asks for very little book-learning. The same few formulæ apply over and over again in different contexts. Practice and experience, more than formal instruction, develop the art of knowing which formula to use when. To help broaden the base of experience, a range of exercises is provided and supplemented with hints, answers, or worked solutions. Every effort has been made to select problems which not only provide the necessary hours of practice but also offer some feature of interest in their own right, whether in relation to the history of the subject, the context of the application, or the occasional touch of humour. Some harder 'challenge' problems are also included.

Students who go beyond the level of this book will eventually find that the marvellous system we are studying, powerful as it is, does not answer all the questions we can ask about the universe. The detailed analysis of planetary orbits, which provided such a convincing demonstration of the Newtonian framework, shows that at extreme levels of accuracy fine adjustments are needed to allow for Einstein's theory of relativity. And, looking back, we may have also lost something of the mediæval outlook, the sense of a prevailing order which holds everything together. But still we have here a glimpse of how lucidly and how beautifully mathematics can bring together different practical, worldly measures into a unified system of law.

Jeremy Pickles, 2006

About the Author

Jeremy Pickles was born in 1946 in Hampstead. He attended Tonbridge School in Kent and was awarded a scholarship to St John's College, Cambridge when he was 16. He spent seven years there, gaining a BA and masters, followed by a PhD in Theoretical Physics with a thesis titled 'Many-body Theory and the Landau Theory of Fermi Liquids' under the guidance of Brian Josephson (later a Nobel Laureate). He was also a Cambridge Blue in athletics, specialising in the 880 yards.

After leaving Cambridge he became a Research Officer at the Central Electricity Research Laboratories for 20 years, with some success; in 1977 he won a prize for a paper on the calculation of electric fields using Monte-Carlo methods. In 1992 he left to set up his own consultancy, Statistics Extremes. A keen advocate of the beauty and relevance of mathematics, he began teaching A-level maths on a part-time, voluntary basis at St James Independent School, where both his sons had been pupils. He was also an active member of the Institute of Mathematics and its Applications and chaired its London branch from 1993 – 1996.

He attended philosophy courses for many years and through these was initiated into meditation and also introduced to Vedic mathematics. This is an old system of mathematics from the ancient Hindu Vedas that was rediscovered in the early 20th century. The simplicity of the techniques interested Jeremy greatly and he gave a number of lectures on Vedic maths together with Andrew Nicholas, Kenneth Williams and James Glover. He also co-authored two books on the subject: 'Introductory Lectures on Vedic Mathematics' and 'Vertically and Crosswise'.



Throughout his years of teaching, Jeremy made up his own homework questions for his pupils. He wanted to give them practical problems that demonstrated how mathematics worked in the world. He also wanted to give his students an insight into the history of mathematics, something often overlooked. He had a great love and understanding of his subject and was able to convey it with patience and simplicity even to the unmathematical mind.

In 2004, I suggested that he write a book incorporating some of his ideas and work sheets so they could be used by others. He was able to complete it just two months before his death from cancer in 2006.

Sine Pickles, 2010

Please click the advert

I joined MITAS because
I wanted **real responsibility**

The Graduate Programme
for Engineers and Geoscientists
[Maersk.com/Mitas](https://www.maersk.com/mitas)

Month 16
I was a construction
supervisor in
the North Sea
advising and
helping foremen
solve problems

Real work
International opportunities
Three work placements

MAERSK

Download free ebooks at bookboon.com

Editor's Note

From 1997 – 1999 I was fortunate enough to attend Jeremy's A-level classes in applied mathematics, studying not only mechanics with him but also statistics. From these I vividly remember the interesting and 'realistic' problems that he set the class; problems which he usually concocted himself. These were not your average 'dry' questions, but involved real-world situations which gave you a true flavour of the use of mathematics in understanding Nature and her effect on us and our surroundings, often with a nice touch of humour. One particularly memorable question started with *Mr E is playing for the Slug and lettuce in the annual cricket match against the Frog and Radiator...* Perhaps unsurprisingly to those who knew him, questions about cricket featured prominently. But aside from the human interest, these questions had a serious objective: to encourage you to think clearly about how to apply mathematics to a problem in order to solve it. This is one of the hardest aspects of applied mathematics (and similarly of physics). Once the problem is concretely phrased in the language of mathematics, one can apply the machinery of 'pure' mathematics to produce a solution, which is often relatively straightforward due to its logical nature. I shall always be grateful to Jeremy for helping to plant a seed of physical understanding in my mind as a result of this.

In fact I have more than this to thank Jeremy for. He and James Glover allowed me to take both Mathematics and Further Mathematics at A-level despite my not having the usual qualifications required. Further to that Jeremy coached me in the mathematics Sixth Term Examination Papers I was required to sit to gain entrance to read Natural Science at Cambridge. More than 10 years on and a degree, masters and PhD later, I indirectly owe my academic training and career to Jeremy and James' leap of faith.

It is therefore a great pleasure to be able to repay some of that debt by helping bring Jeremy's book to fruition. In this task, the book has benefited greatly from the input of a number of other people. On the technical side, James Glover provided a great deal of feedback on the book as well as writing an eloquent preface, John F. Macqueen created solutions to many of the vector problems and consolidated the text as a whole and Kenneth Williams provided valuable comments and errata. In other matters, Jeremy's family Sine, Jonathan and James have been a great support both to me in preparing and editing the text and, no doubt, to Jeremy in writing it. I have tried to ensure that the text and mathematics are both free of errors and clearly presented, and have also added solutions to a number of problems where none existed previously. Undoubtedly some errors/typos will have slipped through my fingers, however, and for those I take full responsibility.

James Bedford, 2010

A note on symbols

A number of mathematical symbols are used in this text, which will be familiar to many readers. For the benefit of the younger or more inexperienced reader, however, here are a few words of explanation regarding some of the symbols used.

Basic symbols: \approx means *approximately equal to*, while \Rightarrow stands for *implies* (often used between steps of working where equations are being simplified for example) and \therefore stands for *therefore*. Multiplication is denoted in the usual ways $- a \times b$, $a \cdot b$ or ab – as is division: $a \div b$, a/b or $\frac{a}{b}$. The universal constant relating the diameter of a circle to its circumference is given the usual symbol π . It has the numerical value 3.14159...

Vectors: For most of the text, vectors are treated informally. However, in *Appendix A*, the notation of writing vectors in boldface is generally employed: \mathbf{a} . The notation \overrightarrow{AB} , meaning the vector taking one from A to B, is also used.

Angles: The greek letters θ and α are often used to label angles. Occasionally they are denoted by ABC, meaning the angle formed by going from point A to point B and then to point C. Angles are treated almost exclusively in degrees, *e.g.* 90° . For conversion to radians (a particularly ‘natural’ way to measure angles, but only occasionally used in the text), one may simply remember that a full circle, *i.e.* 360° , is equivalent to 2π radians. Thus $90^\circ \rightarrow 90 \times 2\pi/360 = \pi/2$ radians. Similarly π radians $\rightarrow \pi \times 360/2\pi = 180^\circ$.

Please click the advert

Brain power

By 2020, wind could provide one-tenth of our planet's electricity needs. Already today, SKF's innovative know-how is crucial to running a large proportion of the world's wind turbines.

Up to 25 % of the generating costs relate to maintenance. These can be reduced dramatically thanks to our systems for on-line condition monitoring and automatic lubrication. We help make it more economical to create cleaner, cheaper energy out of thin air.

By sharing our experience, expertise, and creativity, industries can boost performance beyond expectations. Therefore we need the best employees who can meet this challenge!

The Power of Knowledge Engineering

Plug into The Power of Knowledge Engineering.
Visit us at www.skf.com/knowledge

SKF

Download free ebooks at bookboon.com

1 Kinematics – motion in a straight line

1.1 Galileo and the acceleration due to gravity

Our study of mechanics begins by following the work of Galileo, a famously independent thinker. Born in 1564, in an era in which scientific questions were settled by reference to authority, he pioneered the use of reason and observation. Using his own improved design of telescope, he studied the sunspots on the Sun and showed that Jupiter has moons while our own Moon has mountains. These discoveries challenged the presumption of the time that heavenly bodies could have nothing in common with the Earth and would obey different laws. Later, he came into conflict with the church for asserting that the Earth is not motionless at the centre of the universe, but revolves around the Sun. Seventy years old, and forced by the Inquisition to retract his published opinions, he muttered “But it still moves” even as he signed his recantation.

In those times, not much importance was attached to the precise measurement of the phenomena of nature. Nobody had investigated systematically such basic aspects of experience as the way things fall. It was presumed, though, that an object dropped from a height would fall at a constant rate, this rate – the speed – depending on the weight of the object, with heavier objects falling faster.

Galileo’s inquiring mind found such beliefs inconsistent. If a one pound cannonball, with a lesser natural speed of fall, is attached to a two pound cannonball, will it not slow the larger cannonball down? But, on the other hand, should not the two together make a composite body of weight three pounds, which should fall faster than either of them separately? Arguments such as these led him to make a fresh start on what he called the science of motion.

In Florence you can still see the instruments which Galileo devised for his investigations. Having no stop-watch, he devised a water-clock to measure intervals of time, weighing the flow of water to measure the time elapsed. To allow more precise measurements than were possible in free fall, he studied the descent of a ball rolling down a sloping groove, repeating his measurements hundreds of times.

As a guiding principle in interpreting his data, Galileo looked for simplicity:

in the investigation of naturally accelerated motion we were led . . . following the habit and custom of nature herself . . . to employ only those means which are most common, simple and easy. For I think no one believes that swimming or flying can be accomplished in a manner simpler or easier than that instinctively employed by fishes and birds.

When, therefore, I observe a stone initially at rest falling from an elevated position and continually acquiring new increments of speed, why should I not believe that such increases take place in a manner which is exceedingly simple and rather obvious to everybody?

In modern terminology, he found the very simple rule, that a falling body increases its speed by equal increments in equal intervals of time, that is to say, its *acceleration* is constant.

1.2 Constant acceleration formulæ

Kinematics is the study of movement. The word ‘kinematics’, like the word ‘cinema’, comes from the Greek word *kinesis*, meaning motion. The most basic formula in kinematics is

$$\text{distance} = \text{speed} \times \text{time} , \quad (1.1)$$

which applies in the case of constant speed. From his investigations, Galileo developed further formulæ which apply in the case of constant acceleration. His concern was primarily with the constant acceleration produced by gravity, but the formulæ are valid in any situation, such as a rocket accelerating upwards or a car accelerating on a horizontal road, where acceleration is constant, at least for a time.

The first of these is

$$v = u + at , \quad (1.2)$$

which gives the velocity v attained after accelerating from velocity u at a constant rate a over an interval of time t . While it is referred to as a formula, it is more than just a recipe for calculation. When a is the subject of the equation, we have

$$a = \frac{v - u}{t} , \quad (1.3)$$

which says acceleration is “change in velocity divided by the change in time”. This is the very meaning of acceleration. No-one who understood this should have much difficulty in remembering *Formula (1.3)*.

Galileo’s second formula tells us the total displacement which has resulted by the end of the time interval. If this displacement is denoted by s , then

$$s = \frac{u + v}{2} t . \quad (1.4)$$

This also is a formula which has a natural meaning. On the right hand side $(u + v)/2$ is the average of the initial velocity u and the final velocity v . So *Formula (1.4)* is saying “displacement = average velocity \times time”. Again this is not difficult to remember. The

term ‘displacement’ is used, rather than ‘distance’, to emphasize that the direction of the movement is significant. For example, when a stone is thrown 20 metres into the air and falls to earth again, the total *distance* travelled is 40 metres. But as far as displacement is concerned, the journey up cancels the journey down, so the *displacement* s is zero.

The two formulæ, $v = u + at$, and $s = \frac{1}{2}(u + v)t$, are between them the source of all that needs to be known about constant acceleration. There are other formulæ, and special ways to use them, but there is nothing actually new. Everything else is derived from these two. For example, there is a third formula which results from substituting v from *Formula (1.3)* into the right hand side of *Formula (1.4)*. Then

$$\begin{aligned} s &= \frac{u + v}{2} \times t \\ &= \frac{u + u + at}{2} \times t . \end{aligned}$$

Simplifying, we find

$$s = ut + \frac{1}{2}at^2 . \quad (1.5)$$

Formula (1.5) re-expresses the content of *Formulæ (1.3)* and *(1.4)* in what for some circumstances is a more convenient form.

Please click the advert



Are you considering a European business degree?

LEARN BUSINESS at university level. We mix cases with cutting edge research working individually or in teams and everyone speaks English. Bring back valuable knowledge and experience to boost your career.

MEET a culture of new foods, music and traditions and a new way of studying business in a safe, clean environment – in the middle of Copenhagen, Denmark.

ENGAGE in extra-curricular activities such as case competitions, sports, etc. – make new friends among CBS’ 18,000 students from more than 80 countries.

EFMD **EQUIS** ACCREDITED

AACSB ACCREDITED

ACCREDITED BY ASSOCIATION OF MBAs

CEMS

PTM

See what we look like and how we work on cbs.dk

Download free ebooks at bookboon.com

In the same way, writing *Formula (1.3)* in the form $u = v - at$ and substituting into *Formula (1.4)* gives *Formula (1.6)*

$$s = vt - \frac{1}{2}at^2 . \quad (1.6)$$

There is still one more way to substitute into *Formula (1.4)*. Having substituted for u and v , there remains the option of expressing t as $(v - u)/a$. Putting this into *Formula (1.4)* gives

$$s = \frac{u + v}{2} \times \frac{v - u}{a} .$$

Simplifying this – note $(v + u)(v - u) = v^2 - u^2$ – means that we end up with

$$v^2 = u^2 + 2as , \quad (1.7)$$

which is *Formula (1.7)*.

There is a pleasing and useful symmetry about *Formulas (1.3)* to *(1.7)*. Each of them involves just four of the five variables s , u , v , a and t . And each of these five variables occurs in just four of the formulæ – each formula leaves out a different variable.

1.3 Using the constant acceleration formulæ

Example 1.1

A stone is thrown vertically upwards at a speed of 14 m/s. What is the maximum height achieved?

To answer a question like this, first identify the most convenient constant acceleration formula and then transpose the information in the question into the variables of the formula. In the present example, we know the initial speed $u = 14$ m/s, we require to know the height attained s , and we can presume that the acceleration is the acceleration due to gravity, numerically equal to 9.8 m/s². The fourth variable is not stated in the question, but is nevertheless implied. This is the final speed v , ‘final’ meaning the speed at the end of the time interval which is of interest to us. At its maximum height, the stone is neither on its way up nor on its way down. The speed v must therefore be zero.

To solve for s , the best formula is *Formula (1.7)*, $v^2 = u^2 + 2as$, which relates the unknown s to the three known variables u , v , and a . But there is one decision which has to be taken before the formula can be applied. Which direction is to be taken as positive, up or down? If “up” is taken as positive, then the initial velocity $u = +14$ m/s, but if “down” is positive, $u = -14$ m/s.

There is no right or wrong in this choice. It is only necessary that the choice, once made, is consistently applied. If, here, “up” is taken as positive, then u is positive, and s , being

a height gained, is positive, while a , being the downwards acceleration of gravity, has to be treated as negative.

Putting in these values

$$0^2 = 14^2 + (2 \times (-9.8) \times s) ,$$

from which $s = 10$ m.

Example 1.2

With the same data as in *Example 1.1*, how long does the stone take to return to earth?

There is more than one way to answer this question. The best method is to use

$$s = ut + \frac{1}{2} at^2 .$$

As before, $u = 14$ m/s, $a = -9.8$ m/s². t is the unknown, while $s = 0$ is implied by the statement that the stone returns to earth. The *distance* travelled is 10 metres up and 10 metres down, total 20 metres, but the eventual *displacement* from the starting position is zero. Putting in these values

$$\begin{aligned} 0 &= 14t + \left(\frac{1}{2} \times (-9.8) \times t^2\right) \\ \implies 0 &= t(14 - 4.9t) , \end{aligned}$$

gives $t = 0$ or $t = 20/7$. $20/7$ seconds, or 2.86 seconds, is the answer we need. The $t = 0$ solution reminds us that the stone is also at ground level at $t = 0$, just before being projected upwards.

Another way to answer the question is to first calculate the time to reach the maximum height. The formula

$$v = u + at$$

then tells us that

$$0 = 14 + (-9.8)t ,$$

or $t = 10/7$. Adding another $10/7$ seconds to allow for the downward journey gives the same total time of $20/7$ seconds as before. Although this is a correct answer it does involve the assumption that the times for the upward and downward journeys are equal. Ideally, this would need to be demonstrated mathematically.

Example 1.3

In practice, it is unlikely that the stone in *Example 1.2* would be projected upwards from an initial position exactly at ground level. A more exact calculation would allow for the

height, say 1.4 m, at which the stone was released when thrown upwards. On returning to ground the stone is 1.4 m below its starting point, so that $s = -1.4$. Then

$$s = ut + \frac{1}{2}at^2$$

$$\implies -1.4 = 14t - 4.9t^2 .$$

Multiplying by 10 to eliminate the decimal point, and cancelling a factor of 7 gives

$$7t^2 - 20t - 2 = 0 .$$

A problem about throwing a stone has now been transformed into a quadratic equation. In applied mathematics, pure mathematics can be put to use! The standard ‘quadratic’ formula gives solutions

$$t = 2.95 \text{ secs} \quad \text{or} \quad t = -0.10 \text{ secs} .$$

The negative solution is a little surprising. Pure mathematics is innocent of practical matters and is faithfully reporting to us the valuable information that if the stone finds itself in my hand 1.4 m above the ground, travelling at 14 m/s, it should have taken off from the ground 0.1 seconds ago. The positive solution is rather the one we need. As would be expected, it is just that little bit larger than the value calculated on the assumption that the launch point was at ground level. The calculation could be further elaborated by allowing for the effects of air resistance or for the size of the stone. Whether these refinements are necessary would depend on the use for which the calculation is being done.

Please click the advert



The financial industry needs a strong software platform

That's why we need you

SimCorp is a leading provider of software solutions for the financial industry. We work together to reach a common goal: to help our clients succeed by providing a strong, scalable IT platform that enables growth, while mitigating risk and reducing cost. At SimCorp, we value commitment and enable you to make the most of your ambitions and potential.

Are you among the best qualified in finance, economics, IT or mathematics?

Find your next challenge at
www.simcorp.com/careers



www.simcorp.com

MITIGATE RISK | REDUCE COST | ENABLE GROWTH

Example 1.4

A car is reputed to be capable of reaching 60 miles per hour in 6 seconds, from a standing start. On the assumption of uniform acceleration, what distance would be covered in this time? (1 mile = 1.609 km.) Here, we have an acceleration in the horizontal direction, rather than vertically, but we can still use the formula

$$s = \frac{(u + v)t}{2},$$

though we must remember to express the values in a consistent set of units. We cannot measure time in units of hours, and in units of seconds, in the same equation. If we choose metres and seconds as our standard units, $u = 0$, $v = 60 \times 1.609 \times 1000/3600 = 26.8$ m/s, $t = 6$ seconds. The distance covered comes out as $s = 80.45$, or about 80 metres.

1.4 Velocity-time graphs

As its name implies, a velocity-time graph plots the velocity of a moving object against time. The graph gives us another way to look at the formulæ we have been using.

In the case of an object moving at constant speed, the graph is simply a horizontal straight line:



Figure 1.1: *A velocity-time graph for an object moving at constant speed.*

This is not a very exciting graph but it does illustrate a new idea. The area under the graph forms a rectangle whose height is the constant value of the speed and whose base is the time-interval under consideration. The area of the rectangle is

$$\begin{aligned} \text{area} &= \text{height} \times \text{base} \\ &= \text{speed} \times \text{time} \\ &= \text{distance} . \end{aligned}$$

The area under the graph thus represents the distance travelled.

In a graph representing constant acceleration, velocity is represented by a plot of constant slope equal to the acceleration a , while the initial speed is u and the final speed is v :

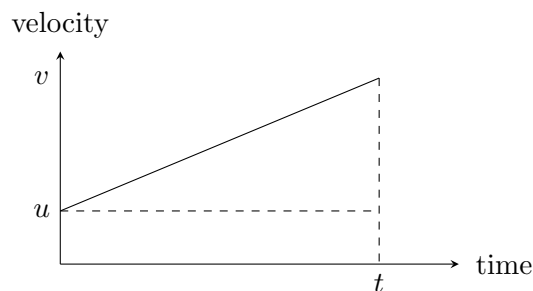

Figure 1.2: A velocity-time graph for an object undergoing constant acceleration.

The area under the graph can be looked at in two ways, as a trapezium or as a combination of a rectangle and a triangle. From the trapezium point of view,

$$\begin{aligned} \text{area} &= \text{average height} \times \text{base} \\ &= \frac{u+v}{2} \times t, \end{aligned}$$

which is another way to look at constant acceleration formula number (1.4). Alternatively,

$$\begin{aligned} \text{area} &= \text{rectangle} + \text{triangle} \\ &= (u \times t) + \left(\frac{1}{2} \times t \times at\right) \\ &= ut + \frac{1}{2}at^2, \end{aligned}$$

which is just constant acceleration formula number (1.5). The general principle, that the area under the graph represents displacement, is in fact true, not just for a straight-line graph, but for a velocity-time graph of any shape.

1.5 Using a velocity-time graph

The constant acceleration formulæ apply, naturally enough, only to time intervals during which acceleration remains constant. When the acceleration takes different values during the period of interest a velocity time graph helps to bring all the information together.

Example 1.5

A car travelling at 15 m/s has to slow to a speed of 5 m/s to get over a speed bump. It starts to decelerate 5 seconds before reaching the bump, takes 1 second to traverse the bump and 5 seconds to accelerate back up to 15 m/s. By how many seconds has the bump delayed the progress of the car?

The velocity-time graph looks like this:

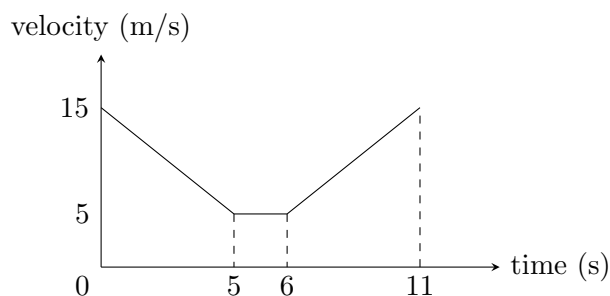

Figure 1.3: A velocity-time graph for a car moving over a speed bump.

The total distance travelled during the 11 second period in question is the total area under the graph. The area breaks up into three parts, a trapezium on the left, a rectangle in the middle, and a trapezium on the right, so

$$\begin{aligned}\text{distance travelled} &= \text{area} \\ &= \left(\frac{15 + 5}{2} \times 5 \right) + (5 \times 1) + \left(\frac{5 + 15}{2} \times 5 \right) \\ &= 105 \text{ metres} .\end{aligned}$$

Without the speed bump, the time taken to cover 105 metres at 15 m/s would be $105/15 = 7$ seconds. With the bump, the time taken is 11 seconds, so the delay is $11 - 7 = 4$ secs.

Example 1.6

A sprinter in a 100 metre race accelerates at 6 m/s^2 for the first two seconds, maintains a constant speed of 12 m/s for the next 2 seconds, and then decelerates at 0.5 m/s^2 for the remainder of the race. Calculate (a) the distance covered in the first 10 seconds and (b) the time taken to complete the race.

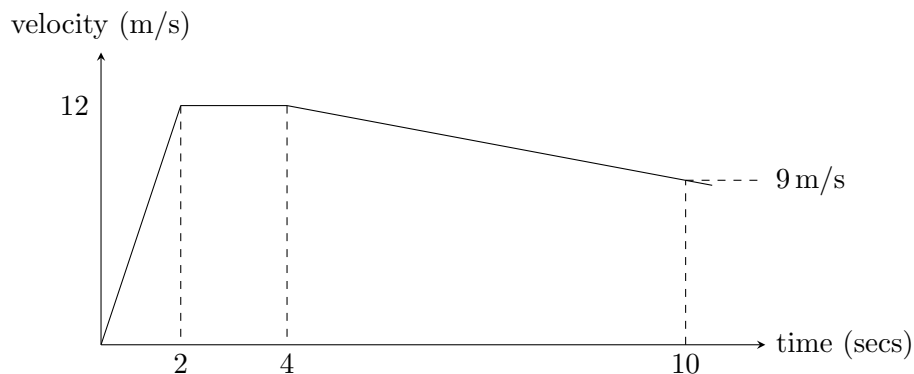

Figure 1.4: A velocity-time graph for the sprinter of Example 1.6.

In the acceleration phase the sprinter covers a distance represented by the triangular area in the velocity-time graph, $\frac{1}{2} \times 2 \times 12 = 12$ metres. At constant speed he covers a further distance $2 \times 12 = 24$ metres. Between $t = 4$ and $t = 10$, his speed falls to $12 - (0.5 \times 6) = 9 \text{ m/s}$. The distance covered is $\frac{1}{2} \times (12 + 9) \times 6 = 63$ metres. The total distance covered in 10 seconds is therefore $12 + 24 + 63 = 99$ metres.

After 4 seconds, the sprinter has covered 36 metres. Over the remaining 64 metres, his acceleration, or rather deceleration, is constant, so that the time taken can be calculated from the formula $s = ut + \frac{1}{2}at^2$, with given data $s = 64$, $u = 12$, $a = -0.5$. Putting in the values gives a quadratic equation for t :

$$64 = 12t - 0.25t^2,$$

which has two solutions, the practically relevant value $t = 6.11$ seconds, and a second solution $t = 41.89$ seconds. This latter corresponds to the unrealistic scenario in which the sprinter continues to decelerate after crossing the finish line, eventually acquiring negative velocity and re-crossing the line from the far side. The time, then, to complete the full 100 metres is $4.00 + 6.11 = 10.11$ seconds.

Notice that the two calculations provide a check on each other. The sprinter has covered 99 metres in 10 seconds and needs a further 0.11 seconds to cover the remaining 1 metre, which is consistent with his speed of just under 9 m/s at this stage of the race.

2 Projectiles

2.1 Separating horizontal and vertical motion

The motion of a projectile such as an arrow or a cannonball reflects both the impetus given to it and the continuing operation of the force of gravity. Before Galileo, scholastic opinion held that the ‘forced’ motion of the initial impetus and the ‘natural’ motion produced by gravity would not mix. It was presumed that the projectile would continue in a straight line along its original direction of motion until its initial impetus was exhausted. Then gravity would take over and it would fall vertically to the ground.

The idea of two motions not mixing contains a grain of truth, but Galileo was able to see that the important distinction was not between ‘forced’ and ‘natural’ motion, but between horizontal motion, however caused, and vertical motion, however caused. He visualized a particle moving on a ‘limited and elevated’ plane, like a ball rolling over the top of a cliff. Before it reaches the cliff edge, it has a constant horizontal speed. The horizontal motion continues as it passes over the edge, but now gravity comes into play as well. The operation of gravity, and its effect on the vertical motion, is not altered by the horizontal motion, nor is the horizontal motion altered by gravity acting vertically.

Example 2.1

A ball, travelling horizontally at 7 m/s, rolls over the edge of a cliff. Where will it be 2 seconds later?

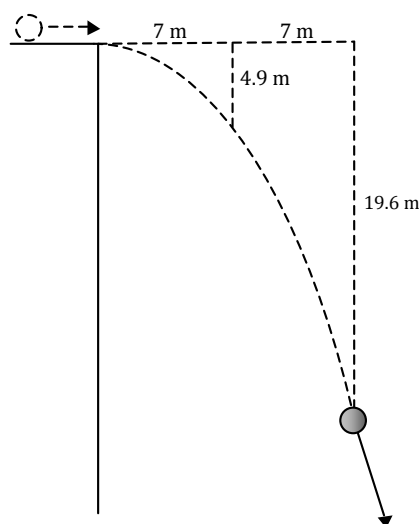

Figure 2.1: *The trajectory of a ball going over a cliff.*

If time zero is the instant when the ball goes over the edge, then, considering its horizontal

motion, it will after one second be 7 metres clear of the cliff face. Considering the vertical motion, the distance fallen under gravity will be the same as if the ball had been dropped from rest, so the usual constant acceleration formula applies

$$s = ut + \frac{1}{2}at^2 ,$$

with u – the initial speed in the *downwards* direction – being zero. With $t = 1$ and, if we take the downwards direction as positive, $a = 9.8 \text{ m/s}^2$, the downwards displacement is $s = 4.9 \text{ m}$.

Repeating the calculation at $t = 2$, the ball is 14 m beyond the cliff face and has fallen through a vertical distance of 19.6 m. These two separate pieces of information combine to fix the position of the ball.

Please click the advert



What do you want to do?

No matter what you want out of your future career, an employer with a broad range of operations in a load of countries will always be the ticket. Working within the Volvo Group means more than 100,000 friends and colleagues in more than 185 countries all over the world. We offer graduates great career opportunities – check out the Career section at our web site www.volvogroup.com. We look forward to getting to know you!

VOLVO
 AB Volvo (publ)
www.volvogroup.com

VOLVO TRUCKS | RENAULT TRUCKS | MACK TRUCKS | VOLVO BUSES | VOLVO CONSTRUCTION EQUIPMENT | VOLVO PENTA | VOLVO AERO | VOLVO IT
 VOLVO FINANCIAL SERVICES | VOLVO 3P | VOLVO POWERTRAIN | VOLVO PARTS | VOLVO TECHNOLOGY | VOLVO LOGISTICS | BUSINESS AREA ASIA

Download free ebooks at bookboon.com

Example 2.2

In the same situation as *Example 2.1*, what is the velocity of the ball after 2 seconds?

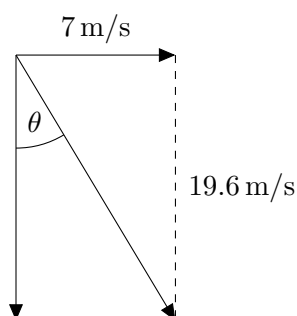

The idea of calculating horizontal and vertical motion separately, and then combining the results, applies to velocity as well as to position. When $t = 2$ seconds, the horizontal velocity is 7 m/s and the vertical velocity is $v = u + at = 0 + 2 \times 9.8 = 19.6 \text{ m/s}$. These can be combined using Pythagoras' theorem. The total speed of the ball is therefore

$$V = \sqrt{(7^2 + 19.6^2)} = 20.8 \text{ m/s} ,$$

inclined at an angle $\theta = \arctan(7/19.6) = 19.7^\circ$ to the vertical.

2.2 Components of velocity

When a particle is projected at an angle of elevation, its initial velocity is directed partly upwards, partly horizontally. We say that it has components of velocity in both the vertical and horizontal directions. The initial velocity has to be separated into its components before the calculations of the vertical and horizontal motions can begin. If the speed of projection is V , and the angle of elevation is θ , then from the trigonometry of the diagram

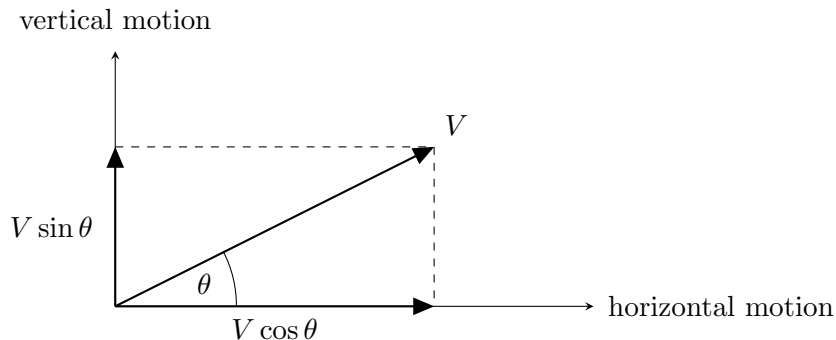

Figure 2.2: *Components of velocity.*

the horizontal component is $V \cos \theta$ and the vertical component is $V \sin \theta$.

Example 2.3

An archer shoots an arrow in a direction 30° above the horizontal with a speed of 50 m/s. (This is thought to be a fairly representative value for an archer with a longbow at the time of the battle of Agincourt.) What height does it attain, and how far does it travel before hitting the ground?

For the arrow, the vertical component of the initial velocity is $50 \sin(30^\circ)$, and the horizontal component is $50 \cos(30^\circ)$.

To find the height attained, it is sufficient to consider just the vertical motion. The arrow has reached its greatest height when the vertical velocity is zero, so using

$$\begin{aligned} v^2 &= u^2 + 2as \\ 0^2 &= (50 \sin(30^\circ))^2 - 2 \times 9.8s, \end{aligned}$$

we find $s = \text{maximum height} = 32$ metres, to 2 significant figures.

To find the range, we need first to find the time of flight. If the position of the arrow at time t is represented by co-ordinates (x, y) , where the origin is the point of projection,

$$y = s = ut + \frac{1}{2}at^2 = 50 \sin(30^\circ)t - \frac{1}{2}9.8t^2.$$

The arrow returns to earth when $y = 0$, so that

$$y = 0 = 50 \sin(30^\circ)t - \frac{1}{2}9.8t^2 ,$$

giving two solutions for t , $t = 0$, which is hardly news, and more interestingly $t = 50 \sin(30^\circ)/(9.8/2) = 5.1$ seconds.

Meanwhile, the horizontal position x is determined by the horizontal velocity component, which remains constant throughout the motion

$$x = 50 \cos(30^\circ)t .$$

After 5.1 seconds, when the arrow returns to earth the horizontal distance covered, in other words the range, is $50 \cos(30^\circ) \times 5.1 = 220.92$, or 221 m to 3 s.f.

2.3 Maximum range

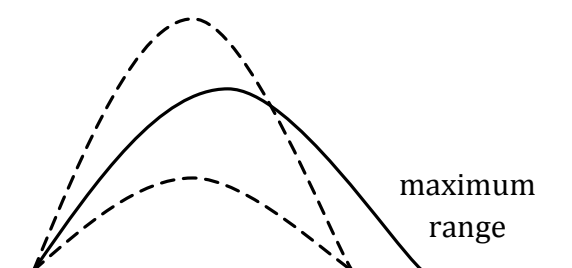

Figure 2.3: *Range of a projectile.*

The range of a projectile depends on its initial speed and the angle of projection. If we suppose the initial speed is V , and the angle of projection is θ , and follow through the arrow calculation of *Example 2.3* with these general variables, the time of flight comes out as $t = V \sin \theta / (g/2)$ and the range is

$$\begin{aligned} \text{range} &= \text{horizontal speed} \times \text{time of flight} \\ &= V \cos \theta \times \frac{V \sin \theta}{(g/2)} \\ &= \frac{2V^2 \sin \theta \cos \theta}{g} . \end{aligned}$$

A formula from trigonometry helps here to simplify this result. $\sin 2\theta = 2 \sin \theta \cos \theta$, so the formula for the range can be stated in the compact form

$$\text{range} = \frac{V^2 \sin 2\theta}{g} .$$

When θ is 45° , $\sin 2\theta$ reaches its maximum value, $\sin(90^\circ) = 1$, and the range reaches its maximum value, V^2/g .

Example 2.4

Find the maximum range for the arrow of *Example 2.3*. Find also the angle of projection for which the range of the arrow is exactly 50% of the maximum achievable.

The maximum range, in the absence of air resistance, and assuming level ground, is $V^2/g = 502/9.8 = 255$ metres. To hit a target at half this distance, the factor $\sin 2\theta$ in the range formula $V^2 \sin 2\theta/g$ must equal 0.5, giving $\theta = 15^\circ$ and $\theta = 75^\circ$ as two possible solutions. It is a general rule that for a given horizontal range there are two possible values of θ , symmetrically disposed about the maximum range angle of 45° . Gunners refer to the large angle solution as ‘plunging’ fire.

Please click the advert

RedStarResume

Do you want your Dream Job?

More customers get their dream job by using RedStarResume than any other resume service.

RedStarResume can help you with your job application and CV.

**Go to: Redstarresume.com
Use code “BOOKBOON” and save up to \$15**

(enter the discount code in the “Discount Code Box”)



2.4 Equation of the trajectory

The constant acceleration formulæ, as used in *Example 2.3*, give equations for x and y . x does not appear in the y -equation, nor y in the x -equation. The time variable t , however, appears in both, and can be used to link them together. In the Example,

$$x = 50 \cos(30^\circ)t$$

so that

$$t = \frac{x}{50 \cos(30^\circ)} .$$

Substituting for t in the y -equation

$$y = 50 \sin(30^\circ)t - \frac{1}{2}9.8t^2$$

gives

$$y = x \tan(30^\circ) - \frac{9.8x^2}{2 \times (50 \cos(30^\circ))^2} ,$$

which is the equation of the trajectory of the arrow, the complete path it traces in the sky.

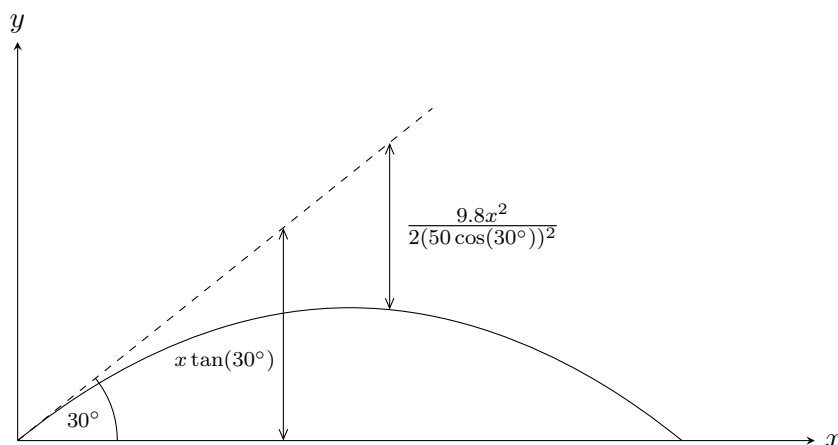

Figure 2.4: *Projectile trajectory.*

Looking at the equation from the point of view of co-ordinate geometry we see that it has the basic pattern

$$y = (\text{constant})x - (\text{constant})x^2 .$$

The first term, $y = x \tan(30^\circ)$, would give a straight line – the path the arrow would take if it continued for ever in its original direction. The second term, which is negative and

involves x^2 , introduces a downward curve reflecting the effects of gravity. We may recognize the curve as a parabola, the name parabola coming from the Greek meaning to fall. Of course, since the coefficient of x^2 is negative, the parabola is upside down compared with the parabolic graphs most often encountered in exercises in pure mathematics.

Example 2.5

Cricketer B hits a ball towards the boundary, aiming to clear the pavilion which is 70 metres away and 8 metres high. If the ball is struck with initial speed V at an angle of 40° to the horizontal, deduce the required value of V .

Here, we may borrow the equation for the arrow, derived above, by replacing the angle 30° by 40° , and the speed 50 m/s by V . So, in coordinates measured relative to the initial position of the ball

$$y = x \tan(40^\circ) - \frac{9.8x^2}{2 \times (V \cos(40^\circ))^2}.$$

If the ball just clears the pavilion, y must be 8 when $x = 70$. Substituting these values in gives an equation

$$8 = 70 \tan(40^\circ) - \frac{9.8 \times 70^2}{2 \times (V \cos(40^\circ))^2},$$

or making V^2 the subject,

$$V^2 = \frac{9.8 \times 70^2}{\cos^2(40^\circ)(70 \tan(40^\circ) - 8)}$$

giving $V = 28.4$ m/s.

Success would require an initial speed at least as large as this, though, as in the case of the arrow, a more exact calculation would have to take into account air resistance.

2.5 The envelope

Consider a hose, squirting a jet of water with a given speed, or an anti-aircraft gun able to fire a shell with a given muzzle velocity. As the angle of projection varies, a range of different possible trajectories is produced. If the target, say P in *Figure 2.5*, is near enough, it can in general be reached by two trajectories with different angles of projection. Other points, such as Q, are out of range, whatever the angle of the gun. The boundary between the region of accessible targets and the region of inaccessible targets is what is called the envelope of the family of parabolic trajectories. The diagram suggests to us what turns out in fact to be true, that the envelope is itself another parabola.

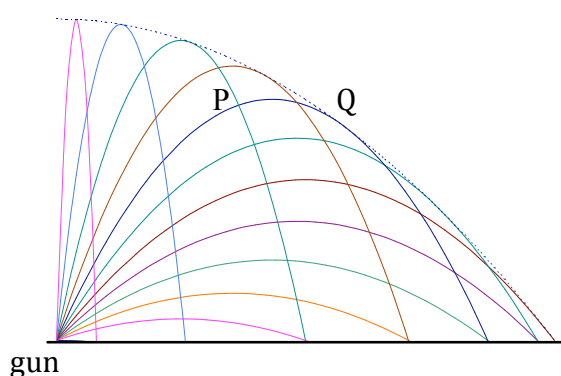

Figure 2.5: *The envelope of the trajectories.*

Example 2.6

A frog squirts a jet of water with speed 7 m/s to catch a fly, hovering one metre away in horizontal distance and 2 m above ground. At what angle θ should the jet be squirted?

The strategy for solving this problem is similar to that of *Example 2.5*, making use of the equation of the trajectory, although the actual solution is more difficult.

With the new data, $x = 1$, $y = 2$, and $V = 7$, and the frog gets the fly if

$$2 = 1 \times \tan \theta - \frac{9.8 \times 1^2}{2 \times (7 \cos \theta)^2},$$

or simplifying

$$20 - 10 \tan \theta + \frac{1}{\cos^2 \theta} = 0.$$

Further progress seems difficult. There is no way to make θ the subject here! A resourceful student might however make progress by calculating the left-hand-side for different values

of θ and seeing where the graph cuts the axis. If the fly is within range, we expect to find two values of θ that fit.

Mathematical connoisseurs will also appreciate an alternative method of solution, partly because it is quicker than drawing a graph and partly because it reveals a hidden simplicity in the awkward equation for θ . The trick is to recognise that the term involving $1/\cos^2\theta$ can be rewritten using the trigonometrical identity

$$\frac{1}{\cos^2\theta} = \sec^2\theta = 1 + \tan^2\theta ,$$

which is Pythagoras' theorem for a right-angled triangle with hypotenuse $\sec\theta = 1/\cos\theta$ and sides $\tan\theta$ and 1. Then the equation becomes

$$\tan^2\theta - 10\tan\theta + 21 = 0 ,$$

which is just a quadratic equation in disguise, with $\tan\theta$ being the unknown. Solving – the equation factorises nicely – gives the values of $\tan\theta$ for a direct hit as 3 and 7 corresponding to solutions $\theta = 71.6^\circ$ and $\theta = 81.9^\circ$.

Try this...



The sequence 2, 4, 6, 8, 10, 12, 14, 16, ... is the sequence of even whole numbers. The 100th place in this sequence is the number...?

Please click the advert

Challenging? Not challenging? Try more >>

www.alloptions.nl/life

Download free ebooks at bookboon.com

3 Forces

3.1 Newton's laws

So far, in kinematics, we have studied the movement of objects or particles without concerning ourselves with the reason why they move. In dynamics, we study the forces which we infer to be the causes of the movements that we see. Like the word dynamite, 'dynamics' comes from the Greek *dunamis*, meaning strength or power.

A mediæval philosopher might have said that an apple falls because it is in its own nature to fall. But now we say that the apple, as inert matter, has no intrinsic power of motion, and must be impelled by some external force. This modern concept of force was formulated by Isaac Newton, born in 1642, the year Galileo died. He was still an unknown student in his early twenties when he made crucial discoveries in calculus, optics, and the theory of gravity. Much of this work was done in a Lincolnshire farmhouse, still there today just off the A1 trunk road, where he retreated from the plague which swept through towns and cities in 1665 – 1666.

Newton's laws of motion state the relationship between the forces and the movements which they produce.

1. The first law is:

Every body continues in its state of rest or of uniform motion in a straight line unless compelled to change that state by forces impressed upon it.

To illustrate this, Newton gives some examples. Projectiles would continue their motion, with the same speed in a straight line, if they were not retarded by the resistance of the air or impelled downwards by the force of gravity. Planets and comets meet with less resistance and so continue their motions for much longer times.

2. The second law is:

The change in motion is proportional to the motive force, and in the same direction as the motive force.

This law is usually expressed in the form of an equation,

$$F = ma , \tag{3.1}$$

where F is the motive force, m is the mass of the body to which the force is applied, and a is what Newton called the change in motion, or as we would now say, its acceleration. Because the law is about change in motion, rather than the motion itself, the effect of the motive force is superimposed on any pre-existing motion of the body.

3. The third law is:

To every action there is an equal and opposite reaction.

Press a stone with your finger, says Newton, and the finger is also pressed by the stone.

It is remarkable that from these three laws, together with the basic ideas of ‘mass’, ‘force’, and ‘body’, Newton could develop what he called his system of the world, explaining the motion of the planets, the comets, the moon and the tides in the sea. At the same time, the laws allow the analysis of a wide range of practical phenomena, like the stability of structures, the motion of vehicles, or the flow of air across the wing of an aeroplane. We could hardly expect the scheme to be so successful unless it in some way reflects the intrinsic laws of the universe. As Galileo expressed it, “The book of nature is written in the language of mathematics”.

3.2 Identifying forces

In mechanics, the forces commonly met with, apart from the force of gravity, are the reaction force when one body presses against another, the tension force when a body is pulled by a rope or string, and the frictional force which arises when a body slides across a surface. A body immersed in a fluid may experience a pressure force from the fluid and a drag force resisting its motion. In all these situations we are guided towards the concept of ‘force’ by our own immediate bodily experience.

Other areas of physics may be concerned with electromagnetic forces or with the forces in the atomic nucleus. In these cases the forces are outside our direct experience and have to be inferred from the motions which appear to be produced.

Forces are measured in units of newtons. A force of one newton, according to the second law, is sufficient to give a mass of one kilogram an acceleration of 1 m/s^2 , so that in the equation $F = ma$ we have $1 = 1 \times 1$. This definition does not tell us what a force actually is, only how to measure it. To appreciate the basic idea of a force we have to refer back ultimately to our own experience as described above.

Example 3.1

Galileo’s experiments show that – in the absence of air resistance – objects fall with an acceleration of $g = 9.8 \text{ m/s}^2$. According to the equation $F = ma$, the gravitational acceleration of a body of mass m must be impelled by a force of magnitude mg . The weight, therefore, of a smallish apple, of mass 0.1 kg , is 0.1×9.8 or about one newton. On the moon, where the acceleration due to gravity is 1.6 m/s^2 , the weight of the apple would be only $0.1 \times 1.6 = 0.16$ newtons.

Example 3.2

A lift of mass 300 kg is pulled upwards by a cable in which the tension is 3300 newtons. What is the acceleration produced?

Although it is not mentioned explicitly in the question, we have to remember that the force of gravity still operates. We cannot turn it off to simplify the calculation. The force ' F ' in $F = ma$ is therefore not the tension on its own, nor the weight on its own, but their combined effect, taken together. This is called the resultant. In this case, if we take the tension, acting in the upward direction as positive, the weight should be treated as negative. Then

$$\begin{aligned} F &= \text{tension} - \text{weight} = ma \\ \Rightarrow 3300 - 2940 &= 300a \end{aligned}$$

and the upward acceleration is found to be $a = 1.2 \text{ m/s}^2$.

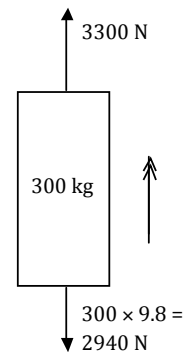

You've applied to your University...

Now Choose
**Your
Bed!**

Nido has some great options left! Live in one of our **twin studios in Nido King's Cross** or **two bedroom studios in Nido Spitalfields**.

Nido is the newest way of living student life in central London. It's not just a residence, it's a way of living that we call 'Nidology'.



Book your room and we will reward you with a £50 voucher from www.voucherepress.co.uk voucher* to spend in London shops! To enter, make a booking with Nido online using the promotional code 'Bookboon01.' For terms and conditions, please visit:

www.NidoStudentLiving.com/Bookboon

WIN a £50 Voucher with every booking!

Nido

Please click the advert

3.3 Equilibrium

A body which is at rest, or travelling at constant speed in a straight line, is said to be in equilibrium. The word implies balance. Before Newton and Galileo, we might have presumed that Mr A sits at rest in his armchair because this happy state of quiet repose is simply the natural condition for a man in an armchair. But, with Newton, we now say that this state of rest is only possible because the upward reaction forces on Mr A from the floor and from the seat of the chair are together exactly equal to his weight. When Mr A sits, he compresses the cushion until the upwards reaction force is just right to maintain the balance.

Mr A in his armchair is an example of static equilibrium, where there is no movement. But the first and second laws show us that a perfect balance of forces is also consistent with motion at a constant speed.

Example 3.3

Mr B, mass 80 kg, stands in the corridor of a train to Glasgow travelling at 100 km/hr. What are the forces on Mr B?

Although Mr B is speeding towards Glasgow at 100 km/hr, he is, according to the first law, in a state of equilibrium. There is no motion in the vertical plane and the speed of the horizontal motion is constant. The forces experienced by Mr B must be in balance so that their resultant is zero. Inside the train, he is shielded from the forces of air resistance, and so there are no forces horizontally, either forwards or backwards.

As far as the balance in the vertical direction is concerned, his weight is $80 \times 9.8 = 784$ newtons and we infer that the reaction vertically upwards from the floor of the train must be of equal magnitude. A reaction force of this kind is often called a ‘normal’ reaction, using the word in the sense of ‘perpendicular’. This is to distinguish it from any frictional force which would act in a direction parallel to the surfaces in contact.

3.4 What is a body?

Newton’s laws imply a distinction between whatever is regarded as a body and the environment which is regarded as outside it. The forces describe the relationship between the two. It is the forces from the environment on the body that enter the calculation – the effect of the earth on the apple, the cable on the lift, the force of the seat cushion on the body of Mr A.

There is no restriction on what may be regarded as a body for the purpose of Newton’s laws. It would be possible to say that Mr A’s head is maintained in equilibrium by an upward reaction force from his neck just sufficient to balance its weight. It is up to the

student to draw the boundary between the body and its surroundings in whatever way is found to be useful. Depending on the point of view, a car may be a single entity, or an assemblage of components, or a cannonball may be viewed in terms of its constituent atoms, each experiencing the forces exerted on it by its neighbours.

Often, Newton's laws are used to describe the motion of a 'particle'. Literally, the term implies a body of zero size, and this would have been a very natural picture for Newton to have in mind as he visualized the motion of a planet through the vastness of space. But more generally, a 'particle' means any body, like the falling apple, or Mr B standing in the train, whose size, shape, or orientation are not considered relevant to the calculation. The only attributes of a particle are its position, velocity, acceleration and mass. Often – but not always – this is a useful simplification.

Example 3.4

Mr C, mass 60 kg, goes up in a lift of mass 340 kg, the tension in the cable being 4200 newtons. What is the upward reaction on Mr C's feet from the floor of the lift?

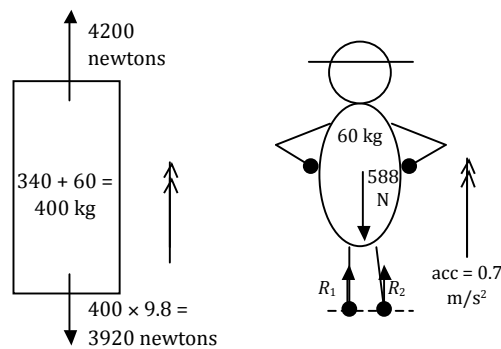

Figure 3.1: *The forces on the lift (left) and the forces on Mr C (right).*

First, apply $F = ma$ to Mr C plus the lift, considered as a single composite body of mass $340 + 60 = 400$ kg and weight $400g = 3920$ newtons.

$$\begin{aligned} F &= \text{tension} - \text{weight} = ma \\ \Rightarrow 4200 - 3920 &= 400a, \end{aligned}$$

giving $a = 0.7 \text{ m/s}^2$. Now apply $F = ma$ to Mr C, considered as a body on his own, subjected to his own weight of 588 N and the reaction forces R_1 and R_2 on his feet from the floor of the lift. Since Mr C's acceleration must be the 0.7 m/s^2 just calculated,

$$R_1 + R_2 - 588 = 60 \times 0.7 = 42.$$

The total reaction force $R_1 + R_2 = R$ is therefore about 630 newtons. Since Mr C is considered as particle, we do not distinguish between the separate forces R_1 and R_2 .

Example 3.5

A bucket of mass 2 kg is suspended from a hook by a chain of mass 0.5 kg. What is the force exerted by the chain on (a) the bucket and (b) the hook?

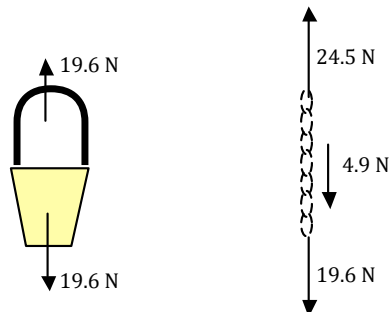

Figure 3.2: *The forces on the bucket (left) and the forces on the chain (right).*

(a) Since the bucket is in equilibrium the chain must exert an upward force on it equal to its weight, $2 \times 9.8 = 19.6$ newtons.

Please click the advert

THIS **ebook** IS PRODUCED WITH **iText**[®]

Download free ebooks at bookboon.com

(b) Together, the bucket and the chain may also be regarded as a body in equilibrium. The force exerted on the combined body from the hook must be equal to the combined weight, $2.5 \times 9.8 = 24.5$ newtons. Necessarily, this force has to be applied at the point where the hook holds the chain. According to the third law, the force exerted by the chain on the hook is equal and opposite, that is to say 24.5 newtons downwards.

The force which the chain exerts on the hook or on the bucket is the tension. Here, because of the weight of the chain, the tension takes different values at the top and the bottom. Exam questions and other problems involving chains or strings often assume that these are “light”, that is to say their mass can be disregarded. In these cases the tension at the two ends of the string are the same.

People sometimes find it puzzling that the force or pull exerted by a string at one end is in the opposite direction to the force exerted at the other end. Consider this from the point of view of, say, a tug-of-war rope. The forces on the rope at its ends are stretching it and must be opposed to each other – if acting together, they would give it an impossibly large acceleration. Similarly the forces exerted by the rope at each end are pulling inwards towards the middle of the rope.

3.5 Connected particles

Example 3.6

The engine of a car supplies a driving force of 1800 N. The car is of mass 1200 kg, including the driver, and pulls a trailer of mass 600 kg. If there are no resistance forces, what is the acceleration produced, and the tension in the tow-bar?

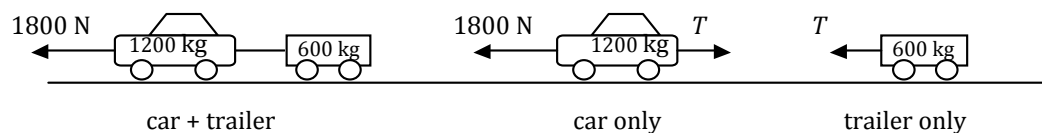

Applying Newton’s second law to the car and trailer together

$$1800 = (1200 + 600)a ,$$

so the acceleration is $a = 1 \text{ m/s}^2$. If T is the tension in the tow bar, then applying the second law to the trailer on its own

$$T = 600a = 600 \text{ newtons.}$$

Note that the driving force plays no direct part in the equation for the trailer. The trailer does not know about the engine. It is only via the tow-bar that the driving force is communicated.

The same answer for the tension T could equally well be provided by applying the second law to the car:

$$1800 - T = 1200a ,$$

confirming the same value for the tension.

Problems of this kind are referred to as ‘connected particle’ problems. They illustrate how Newton’s methods for single bodies or particles can be extended to complex systems. While Newton’s laws presume a division of the universe into distinct entities or particles, the example of the tow-bar indicates how, at least in principle, we bring the separated particles together again.

Example 3.7

Weight A, of mass 5 kg, is connected to weight B, of mass 2 kg, by a light cord which passes over a pulley. Initially, the cord is taut and A and B hang down on either side of the pulley. What is the acceleration when the system is released?

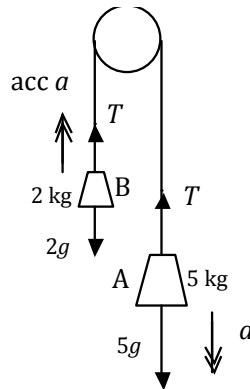

Figure 3.3: *The pulley system of Example 3.7*

Pulley problems can be confusing to the uninitiated. We know that when the system is released, A will go down, and B will go up. With its separate parts going in different directions, it is difficult to visualize an equation for the system as a whole.

Instead, we have to work with equations which represent Newton’s second law applied to each of A and B separately. If the string is inextensible, the downwards acceleration of A must be the same as the acceleration of B upwards. We do not know its value, but we can call it a . And if there is no friction in the pulley, the tension in the string will be the same on both sides, and we can call it T . This may not seem like progress, but it allows us to write down Newton’s equations for A and for B:

Under the force of its own weight, A will accelerate downwards, and the tension in the cord will act to slow its descent

$$49 - T = 5a .$$

B will accelerate upwards, its weight acting downwards being insufficient to overcome the upward pull of the cord. If the string is inextensible we may say that the acceleration of B upwards is the same as that of A downwards, so that

$$T - 19.6 = 2a .$$

By naming the unknowns and writing down the equations of motion, applied mathematics has completed its job. It has presented us with simultaneous equations in the unknowns a and T . Now it is up to pure mathematics to solve them. In this case the easiest route is to add the two equations together so that the T 's cancel out.

$$\begin{aligned} 49 - T + T - 19.6 &= 5a + 2a \\ \Rightarrow 29.4 &= 7a , \end{aligned}$$

so $a = 4.2 \text{ m/s}^2$.

The tension T , if we require it, can now be found by substituting back for a in one of the equations, giving $T = 28$ newtons.

Please click the advert

Fast-track your career

Masters in Management



London Business School
Regent's Park
London NW1 4SA
United Kingdom
Tel +44 (0)20 7000 7573
Email mim@london.edu
www.london.edu/mim/

Stand out from the crowd

Designed for graduates with less than one year of full-time postgraduate work experience, London Business School's Masters in Management will expand your thinking and provide you with the foundations for a successful career in business.

The programme is developed in consultation with recruiters to provide you with the key skills that top employers demand. Through 11 months of full-time study, you will gain the business knowledge and capabilities to increase your career choices and stand out from the crowd.

Applications are now open for entry in September 2011.

For more information visit www.london.edu/mim/
email mim@london.edu or call +44 (0)20 7000 7573

4 Resistance forces

4.1 Air resistance

Galileo was aware that his proposition that every object falls with the same acceleration was an idealization. Dropped from a tower, a cannonball will reach the ground slightly sooner than an apple, while a leaf or a spider hardly seems to fall at all. He recognized, though, that these differences arose not from differences in the effects of gravity but from differences in the effects of air resistance.

Modern engineers use a formula to estimate the force of air resistance or drag. For an object with cross section A , moving at speed v through a fluid of density ρ , the drag is

$$D = \frac{1}{2}C_d A \rho v^2, \quad (4.1)$$

where C_d , which depends on the shape of the object, is called the drag coefficient. This is not a fundamental law, in the same way that Newton's laws are fundamental. Rather, the formula sums up for practical purposes the effects of the complex eddying fluid flow around the moving object, and the coefficient C_d is most easily found by experiment. For a sphere, or a streamlined car, C_d is about 0.3, compared with a value of 0.8 or more for a parachute.

Looking at the formula we see that, as might have been expected, the drag force increases with the size of the moving body, and with the density of the fluid which must move to let the body through. The drag also increases with the square of the speed v , so that it rapidly becomes significant as the body picks up speed.

Example 4.1

The fastest recorded tennis serve is 150 mph, or about 66 m/s. Estimate the extent to which the ball would be slowed by air resistance by the time it passes over the net about 0.2 seconds later.

In the formula for the drag force, we substitute values for the drag coefficient for a sphere, $C_d = 0.3$, the radius of the ball, 3.2 cm, the density of air 1.2 kg/m^3 , and the speed $v = 66 \text{ m/s}$, giving

$$D = 0.5 \times 0.3 \times \pi(0.032)^2 \times 1.2 \times 66^2 = 2.5 \text{ newtons},$$

and taking the mass of the ball as 58 grams, the consequent deceleration will be, by Newton's second law

$$a = D/m = 43 \text{ m/s}^2.$$

After 0.2 seconds the speed would be

$$v = u + at = 66 - 43 \times 0.2 = 57 \text{ m/s}.$$

Of course, this is only an approximate value, since the drag force, and so the acceleration of the ball, are actually changing continuously as its speed reduces.

4.2 Terminal velocity

If an object is dropped from a sufficient height and gains speed as it falls, there comes a point when the drag force equals its weight. The ball is now in equilibrium, as defined in *Section 3.3*, and no further acceleration will occur. The speed v_t at which this happens is called the terminal velocity, and can be calculated from the equation

$$\text{Drag force} = D = \frac{1}{2}C_dA\rho v_t^2 = mg = \text{weight} . \quad (4.2)$$

Example 4.2

Calculate the terminal velocity for the tennis ball of *Example 4.1*.

Substituting in the values,

$$0.5 \times 0.3 \times \pi(0.032)^2 \times 1.2 \times v_t^2 = 0.058 \times 9.8 ,$$

gives $v_t = 31 \text{ m/s}$.

Table 4.1 shows values of the terminal velocity for some other bodies of different sizes and weights.

Body	Radius, m	Mass, kg	Terminal velocity, m/s
Raindrop	0.001	4.2×10^{-6}	6.6
Table tennis ball	0.02	0.0027	8.4
Apple	0.03	0.10	34
Football	0.11	0.43	25
Iron cannonball	0.075	13.9	160
Skydiver		70	55

Table 4.1: *Terminal velocities for free fall through air.*

We see that *Table 4.1* largely bears out the early idea that larger, heavier objects fall faster. The underlying principle of equal gravitational acceleration is only directly observable in the first few tenths of a second after an object is dropped, before air resistance has a significant effect. From the vantage point of the twenty-first century, it is easy to look back on the mediæval view of mechanics with a certain air of superiority. But, without the help of Galileo and Newton, we also might have found it hard to look beyond our own immediate experience.

Example 4.3

Sketch the velocity time graph for the tennis ball as it is dropped from rest at time $t = 0$.

Two pieces of information help us to determine the shape of the curve. First, we know that at $t = 0$, when the downward velocity of the ball is zero, the air resistance force is zero and the acceleration is simply the gravitational acceleration $g = 9.8 \text{ m/s}^2$. This fixes the initial slope of the $v-t$ graph. And secondly we know that the velocity can never exceed the terminal velocity. We expect therefore that the gradient of the graph reduces, as t increases and air resistance has a greater effect, becoming almost zero as it approaches the terminal velocity.

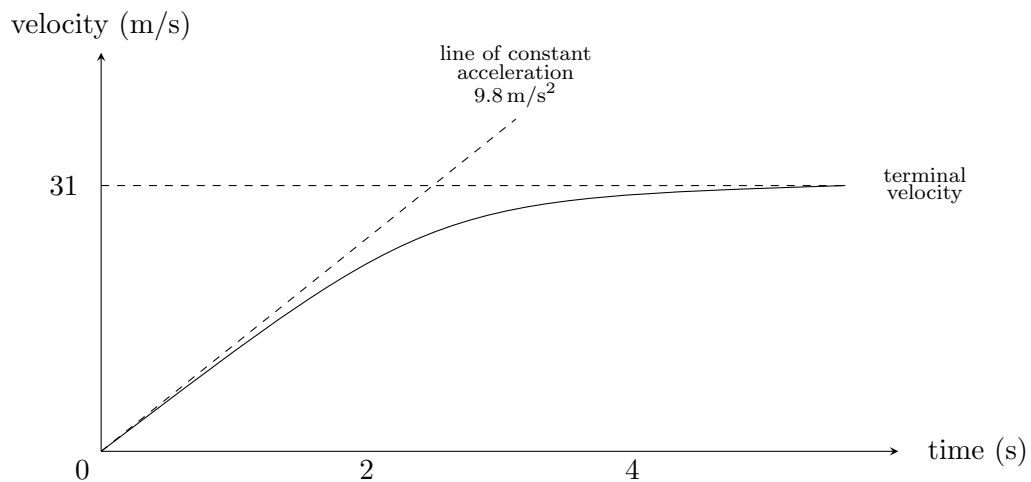

Please click the advert



You're full of *energy*
and *ideas*. And that's
just what we are looking for.

Looking for a career where your ideas could really make a difference? UBS's Graduate Programme and internships are a chance for you to experience for yourself what it's like to be part of a global team that rewards your input and believes in succeeding together.

Wherever you are in your academic career, make your future a part of ours by visiting www.ubs.com/graduates.

www.ubs.com/graduates



© UBS 2010. All rights reserved.

4.3 Dynamic friction

Friction was first studied by Leonardo da Vinci but the formulæ we now use originate with Charles Coulomb, the same Coulomb whose name is commemorated in the name for the unit of electric charge. His thesis on friction, completed in 1781, won a prize offered by the French Academie des Sciences for “...new experiments, made on a large scale, and applicable to machines valuable to the Navy, such as the pulley, the capstan and the inclined plane...”.

Friction occurs when two surfaces are in contact, and it opposes any tendency of one surface to slide across the other. If the surfaces are in fact in relative motion, the resistive force is ascribed to dynamic friction. If on the other hand the resistive force is sufficient to prevent any motion it is ascribed to static friction. The two kinds of friction are very closely related but it is convenient to consider dynamic friction first.

Coulomb’s key insight was the realization that the magnitude of the frictional force does not depend, as one might have expected, on the area of the two surfaces which are in contact, or on the speed of their relative motion, but only on the nature of the two surfaces in contact and the reaction force between them. Experiments show that the frictional force is very well approximated by the formula

$$F_f = \mu N , \quad (4.3)$$

where N is the normal reaction force and μ is the coefficient of friction which is determined by the nature of the two surfaces. This formula is often called the law of friction.

For example, suppose Mr B, mass 80 kg, is skating on an ice rink. The normal reaction force from the ice must balance his weight, 784 newtons. If the coefficient of friction between the ice and the steel blades of his skates is $\mu = 0.05$, the frictional force opposing his motion will be $F_f = 0.05 \times 784 = 39.2$ newtons.

The formula also tells us – because there is no dependence on the areas of the surfaces in contact – that the frictional force F_f remains the same, regardless of whether Mr B has both skates in contact with the ice or glides elegantly along on a single blade. Similarly, if Mr C, mass 60 kg, now skates alongside Mr B, the coefficient of friction will be the same, because the surfaces in contact, ice and steel, are the same. But since Mr C weighs less than Mr B, the normal reaction is only 588 newtons. The frictional resistance to the motion of Mr C is therefore $0.05 \times 588 = 29.4$ newtons.

Table 4.2 shows some typical values for the coefficient of friction μ for a range of surfaces and materials.

Example 4.4

At the scene of a road accident, the car driven by Mr A is found to have left skid marks 15 metres long. Estimate Mr A’s speed just before he applied the brakes.

Surfaces in contact	Typical value or range of values for μ
Car on dry road	0.7 – 0.8
Car on wet road	0.5
Car on icy road	0.1
Oak on oak	0.5 – 0.6
Train on railway line	0.2 – 0.3
Steel on teflon	0.04
Moving parts inside the human kneecap	0.02

Table 4.2: *Typical values for the coefficient of friction.*

We suppose that the coefficient of friction between the tyres and the road is – according to *Table 4.2* – $\mu = 0.7$. We are not told the mass of the car, but can suppose that it is M kg. Then the frictional force which slows the car, once the wheels have locked and the tyres slide across the road surface, is $F_f = \mu Mg$ and the deceleration of the car is determined by Newton’s second law, $F = -F_f = Ma$. The unknown mass M cancels from the equation and we find $a = -\mu g = -6.86 \text{ m/s}^2$, the minus sign indicating that the frictional force opposes the motion and the car is slowing down.

The speed of the car at impact, v , and the speed of the car before the brakes were applied, u , are linked by the constant acceleration formula

$$v^2 = u^2 + 2as .$$

We do not know v , but it will at any rate be greater than zero. The acceleration a we have just calculated and the distance s is equal to the length of the skid marks. So the minimum estimate for the initial speed u is given by

$$\begin{aligned} 0 &= u^2 + 2 \times -6.86 \times 15 \\ \Rightarrow u &= 14.3 . \end{aligned}$$

Before the accident, therefore, Mr A was travelling no slower than 14 m/s, or 32 mph.

4.4 Static friction

The general tendency of frictional forces is to oppose relative motion between two surfaces, and the term ‘static’ friction describes the case when relative motion is altogether prevented. For example, a mass M , resting on a rough horizontal surface, and subjected to a horizontal force P , will remain at rest when P is small, because the frictional forces are sufficient to maintain equilibrium. The mass will only be dislodged when P exceeds a threshold equal to the maximum static frictional force achievable. See *Figure 4.1*.

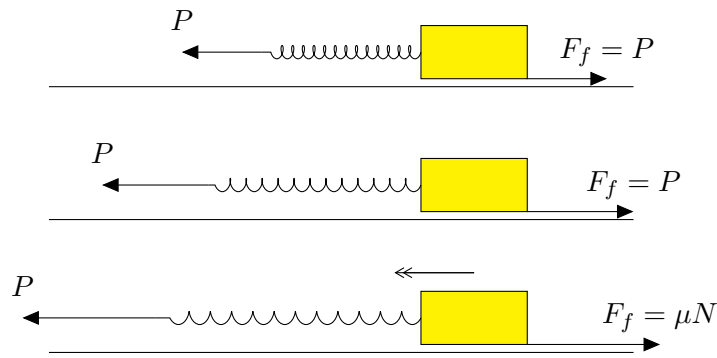

Figure 4.1: An illustration of static friction and the transition to dynamic friction as P is increased.

It is usually accepted that the maximum friction, which P must overcome, is equal to the dynamic frictional force μN which will operate once sliding does actually occur. Since this is a maximum value, the law of friction for static friction takes the form

$$F_f \leq \mu N . \tag{4.4}$$

The coefficient of friction, μ , is hard to measure reliably in the static case and there is some evidence that the ‘static’ value of μ is larger than the ‘dynamic’ μ – in other words it is easier to keep the movement going than it is to get it started. For the purposes of calculation, though, we shall be assuming that the two values of μ are the same.

Please click the advert

© Inter IKEA Systems B.V. 2009

It's only an opportunity if you act on it

IKEA.SE/STUDENT











Example 4.5

Mr B is in his garden and places a pile of flowerpots against the shed door to stop it blowing shut. The coefficient of friction between the pots and the ground is 0.7. How many pots, mass 0.5 kg each, are needed to withstand a force from the door of 20 newtons?

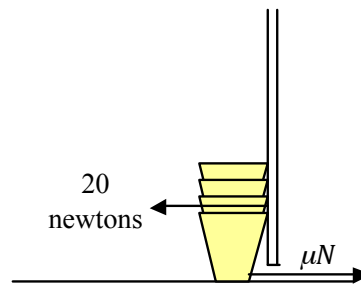
Figure 4.2: *Flowerpots resisting a door.*

If Mr B uses n pots, the normal reaction between the ground and the pots will be $N = n \times 0.5 \times 9.8 = 4.9n$ newtons and the limiting frictional force will be $\mu N = 4.9\mu n$ newtons. To match a force of 20 newtons, $4.9\mu n = 3.43n = 20$, giving $n = 5.83$, or, since pots come in whole numbers, $n = 6$.

Example 4.6

Mr C puts his toolbox, total mass 15 kg, on the floor in the rear of his van. Later, while driving, he is obliged to brake suddenly, decelerating at 5 m/s^2 . If μ is the value of the coefficient of friction between the toolbox and the floor of the van, what is the value of μ which will prevent the tools from sliding forwards when he brakes?

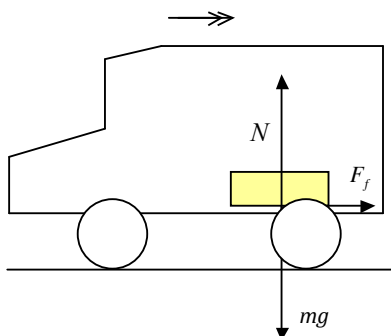
Figure 4.3: *Mr C's van and toolbox.*

The van and the toolbox are both in motion, but, in so far as we are hoping that there will be no relative motion, this is nevertheless a problem in static friction. When the van decelerates, the toolbox, not itself experiencing any direct braking force, will tend to continue forwards at constant speed. To decelerate, it must be retarded by the frictional force from the floor of the van.

From Newton's second law, therefore

$$F_f = ma = 15 \times 5 = 75 \text{ newtons .}$$

But from the law of friction

$$F_f \leq \mu N ,$$

where the normal reaction N is equal to the weight of the toolbox. Hence

$$F_f = 75 \leq \mu N = \mu \times 15 \times 9.8 ,$$

giving $\mu \geq 0.51$.

Example 4.7

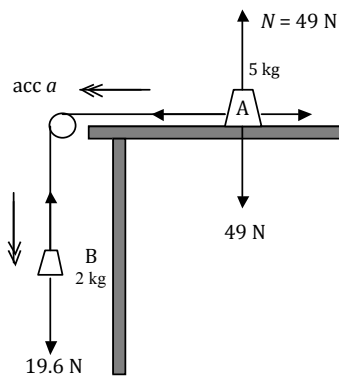

Mass A, of mass 5 kg, is connected to mass B, of mass 2 kg, by a light string which passes over a pulley. Initially, the string is taut with A resting on a horizontal table while B hangs down at the side. The coefficient of friction between A and the table is $\mu = 1/7$. What is the acceleration when the system is released? What happens if $\mu = 3/7$?

Please click the advert

YOUR CHANCE TO CHANGE THE WORLD

Here at Ericsson we have a deep rooted belief that the innovations we make on a daily basis can have a profound effect on making the world a better place for people, business and society. Join us.

In Germany we are especially looking for graduates as Integration Engineers for

- Radio Access and IP Networks
- IMS and IPTV

We are looking forward to getting your application!
To apply and for all current job openings please visit our web page: www.ericsson.com/careers

ericsson.com



This is a variant of the pulley problem of *Chapter 3*, and the same principles apply. We apply Newton's law separately to mass A and to mass B and solve the resulting simultaneous equations. Considering the horizontal motion of A, the tension in the cord T, acting to the left, is opposed by the force of friction F_f acting to the right. The equation of motion is therefore

$$T - F_f = 5a .$$

We assume, provisionally, that motion does indeed occur, so that the frictional force will take its limiting value, $F_f = \mu N = 1/7 \times 5 \times 9.8 = 7$ newtons.

If the string is inextensible, the downwards acceleration a of B is the same as the horizontal acceleration of A. And if the pulley is frictionless, the tension in the string is the same on each side. So with the same variables a and T , the equation for the downward motion of B is

$$19.6 - T = 2a .$$

Solving, we find the acceleration is 1.8 m/s^2 .

For the larger value of $\mu = 3/7$, the limiting value of the frictional force on A is $\mu N = 21$ newtons. This is larger than the weight of B, so the system remains at rest, with $a = 0$, $T = 19.6$ newtons and $F_f = 19.6$ newtons, less than the limiting value.

4.5 Rolling motion

The rolling of a wheel can be regarded as the combination of two separate motions, the rotation of the body of the wheel around its centre and the steady progression of the centre itself. A given point P on the circumference, when near the top of the wheel, will be moving faster than the centre, because here the effects of the rotation and the steady translation tend to add. Conversely, when near the ground, it will be moving more slowly. Approaching contact, the direction of motion becomes vertically downwards, and P is lowered towards the ground, while after contact, P lifts off vertically upwards, rather as the soles of our feet do when we walk.

If we follow P through a complete revolution it traces out in space a mathematically interesting curve known as a cycloid. The crucial point is that, P, at the moment it is in contact with the ground, is instantaneously at rest. Consequently, there need be no frictional force resisting the motion.

This is the situation in freewheeling motion, but when, say, a car accelerates, there are additional forces from the engine which are directed to increasing the speed of rotation of the driving wheels. With an increase in rotation speed, the point on the wheel in contact with the ground would tend to slip backwards, except that a frictional force, acting in a forwards direction, opposes the relative motion. We are led therefore to the seemingly paradoxical conclusion that it is the force of friction which is ultimately responsible for driving the car forwards.

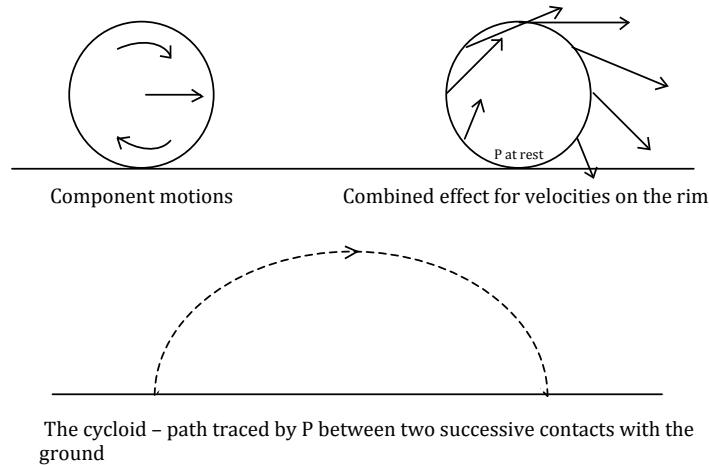

To confirm, consider that Newton’s third law says that the force exerted by the car, on the road, is in the opposite direction, that is backwards. The effect of this is seen for example in the shower of mud or grit which is projected backwards when a car moves off rapidly on a loose surface.

Please click the advert

I joined MITAS because
I wanted **real responsibility**

The Graduate Programme
for Engineers and Geoscientists
[Maersk.com/Mitas](https://www.maersk.com/mitas)



Real work
International opportunities
Three work placements



Month 16
I was a construction
supervisor in
the North Sea
advising and
helping foremen
solve problems



Download free ebooks at bookboon.com

5 Resolving forces

5.1 Vector addition

Forces are ‘vector’ quantities. They have direction as well as magnitude. Consequently, we cannot necessarily say that a force of 15 newtons, plus a force of 10 newtons, makes a total force of magnitude 25 newtons. 25 newtons is a maximum figure, but depending on the directions, the answer might be as small as 5 newtons.

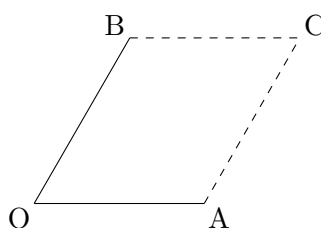

Figure 5.1: *The parallelogram OBCA.*

When forces combine they follow the parallelogram law. Suppose, says Newton, that a body, initially at rest at O , is acted on by two forces F_A and F_B . Applied separately, F_A would in a given unit of time take the body to A , while F_B would take it to B , as shown. Now complete the parallelogram, drawing AC parallel to OB and BC parallel to OA .

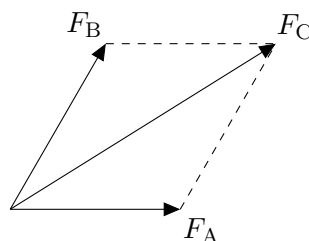

Figure 5.2: *The corresponding parallelogram of forces.*

When force F_A operates, it carries the body in the direction of A , towards the line AC . But this progression of the body towards AC is not altered by force F_B , acting in the direction OB , which is parallel to AC . The body will arrive at the line AC at the same time, independently of whether F_B acts or not. By the same argument, the body will arrive at the line BC , regardless of whether F_A acts or not. Consequently, at the end of the given unit of time, the body must be at C , which lies both on AC and BC . The force F_C , which would in this same time have carried the body directly to C , is the resultant of the separate forces F_A and F_B , their combined effect.

The parallelogram in *Figure 5.1* above is a diagram of the movements or displacements occurring in the given time t . The lengths of the lines represent the distances moved, and,

since the body was initially at rest, the lengths are also proportional to the accelerations ($s = 0t + \frac{1}{2}at^2$, for the same t). By Newton's second law, the accelerations are in turn proportional to the forces. So the parallelogram geometry applies equally to the forces. If F_A and F_B are two forces represented in magnitude and direction by two sides of a parallelogram, their resultant F_C is represented by the diagonal. See *Figure 5.2*.

A specially simple case is when the forces F_A and F_B are perpendicular. Then Pythagoras' theorem applies and the resultant F_C has magnitude equal to $\sqrt{(F_A^2 + F_B^2)}$.

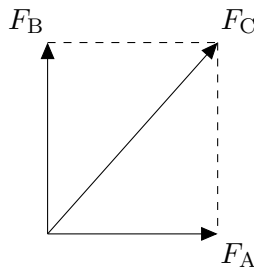

Figure 5.3: *The special case of perpendicular forces.*

5.2 Components of a force

The geometrical argument for calculating the resultant can be used in the reverse direction, to express an oblique force F as the sum of two perpendicular forces. These forces, in the x - and y -directions say, are called the x - and y -components of F .

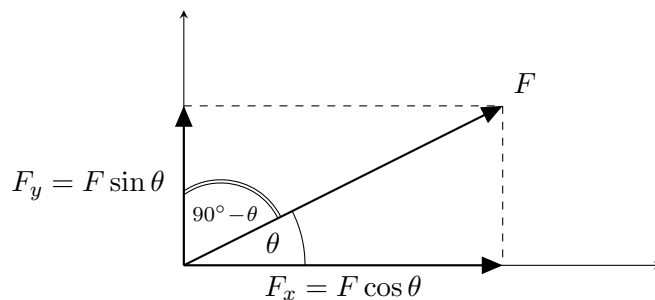

Figure 5.4: *The components of a force, F .*

From the diagram, F_x , the component of F along the x -axis, is $F_x = F \cos \theta$, where θ is the angle between F and the x -axis. Similarly, $F_y = F \sin \theta$. These properties of the force components follow exactly the same idea that we have already used for velocity components in our analysis of projectiles.

5.3 Resolution of forces

We have called our axes x and y , but there is no rule which says that these have to be horizontal and vertical, or east and north, or in any other fixed directions. The intelligent approach is to adapt the axes to the problem at hand. Then if F is a force which is inclined at an angle θ to some important direction OD, the component of F along the chosen direction OD is $F \cos \theta$.

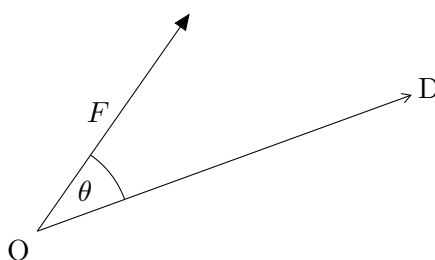

Figure 5.5: The force F acts at an angle θ to OD.

The mental process of choosing an axis or direction, and calculating the components of forces along the chosen axis, is called ‘resolving’ forces.

Please click the advert

An advertisement for SKF. The background is a blue-tinted image of a woman with long dark hair smiling, with a wind turbine visible behind her. The text is white and blue.

Brain power

By 2020, wind could provide one-tenth of our planet's electricity needs. Already today, SKF's innovative know-how is crucial to running a large proportion of the world's wind turbines.

Up to 25 % of the generating costs relate to maintenance. These can be reduced dramatically thanks to our systems for on-line condition monitoring and automatic lubrication. We help make it more economical to create cleaner, cheaper energy out of thin air.

By sharing our experience, expertise, and creativity, industries can boost performance beyond expectations. Therefore we need the best employees who can meet this challenge!

The Power of Knowledge Engineering

Plug into The Power of Knowledge Engineering.
Visit us at www.skf.com/knowledge

Download free ebooks at bookboon.com

Example 5.1

A force of $P = 500$ newtons is applied to a railway truck of mass 2500 kg, at angle of 30° to the line of the track. There is a resistance force of 300 N directly opposing the motion. What is the acceleration of the truck?

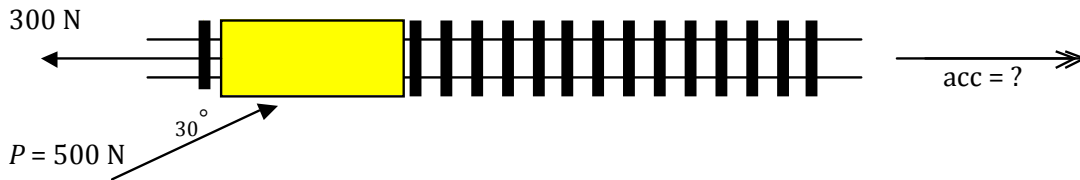

In this example, we may presume that the truck will stay on the rails, so that we are only concerned with motion along the track. We therefore focus our attention only on the forces which act in this direction, or, for an oblique force like P , only on the component of P in the direction of the track. There are of course other forces acting, such as the weight of the truck, which acts downwards, and the transverse force from the rails which keeps the truck on line, but we do not include these in the calculation of the motion *along* the track. Resolving forces parallel to the track, therefore, we write Newton's second law $F = ma$ as

$$500 \cos(30^\circ) - 300 = 2500a$$

The first term on the left hand side is the component of P along the direction of the track and the second term, which is the resistance force, enters with a minus sign because it opposes the motion. Solving for the acceleration, we find $a = 0.05 \text{ m/s}^2$.

Example 5.2

Mr C, mass 60 kg, freewheels downhill on his bicycle, mass 5 kg. If the slope is inclined at an angle of 10° to the horizontal, and air resistance and frictional forces can be neglected, what is his acceleration?

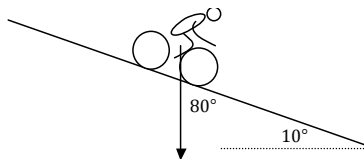

Here, the force driving the acceleration is the combined weight of Mr C and his bicycle, 637 newtons. This acts vertically downwards, but it is best to resolve forces in the direction of the actual motion, which is down the slope. This is perfectly legitimate – we are not restricted to axes only in the horizontal or vertical directions. With the slope at 10° to the horizontal, the angle between the weight, acting vertically downwards, and the direction of motion, down the slope, is 80° . Resolving down the slope, and treating

Mr C and the bicycle as a single ‘particle’, gives Newton’s law in the form

$$\begin{aligned} 637 \cos(80^\circ) &= 65a \\ \rightarrow a &= 1.7 \text{ m/s}^2 . \end{aligned}$$

A very slightly quicker route in this type of problem depends on the trigonometrical identity $\cos \theta = \sin(90^\circ - \theta)$. Our expression for the component of Mr C’s weight which acts down the slope, $637 \cos(80^\circ)$, can be equally well written as $637 \sin(10^\circ)$, which relates the force component directly to the angle of inclination of the slope.

Example 5.3

Two weights W_1 and W_2 are connected by a string which passes over a smooth pulley. W_1 is suspended vertically below the pulley while W_2 rests on a smooth slope which is inclined at an angle α to the horizontal, where $\tan \alpha = 3/4$. How should W_1 and W_2 be related if the system is to rest in equilibrium?

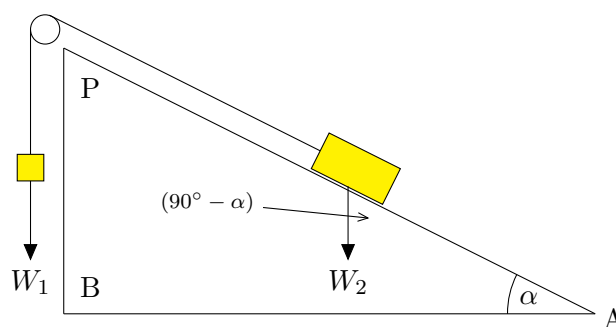

Since the weights are at rest, this problem would be classed as an exercise in statics – as compared with *Examples 5.1* and *5.2* which are applications of dynamics. The only difference is that here the value of the acceleration happens to be zero. The arguments we use are exactly the same.

Suppose the tension in the string is T . Then, considering the equilibrium of W_1 ,

$$T = W_1 ,$$

while resolving down the slope gives the condition for the equilibrium of W_2 :

$$T = W_2 \cos(90^\circ - \alpha) = W_2 \sin \alpha .$$

The angle α comes from a right-angled 3, 4, 5-triangle, so that $\tan \alpha = 3/4$, $\sin \alpha = 3/5$, $\cos \alpha = 4/5$, and so

$$W_1 = T = W_2 \sin \alpha = \frac{3W_2}{5} .$$

Another way to look at this answer is to replace the single weight W_1 by three equal weights w and similarly the weight W_2 by five weights w . We can suppose that the weights are equally spaced on the string, so that three weights w lie on BP which, because of the 3, 4, 5 geometry is 3 units long, and five w 's on AP which is 5 units long.

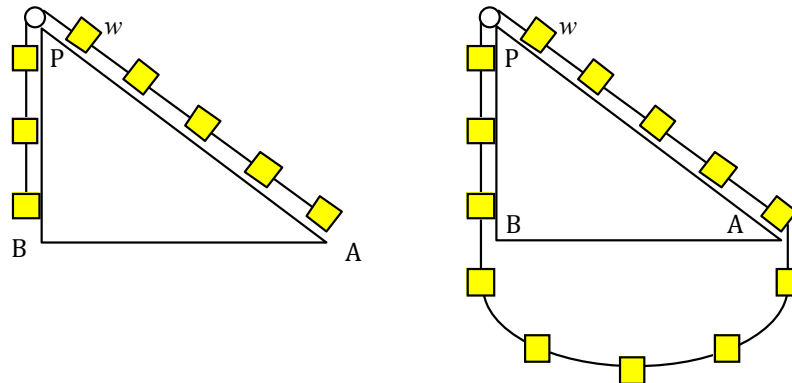

Figure 5.6: *Simon Stevin's solution to the problem.*

If we imagine the weights on AP and BP form part of a continuous loop, we expect the loop as a whole to remain in equilibrium. Any tendency to rotate one way or the other would constitute a perpetual motion machine. But the loop segment BA, taken on its own, is clearly in balance which implies that the weights on BP and AP must balance each other, in agreement with the conclusion we have reached by resolving forces. This elegant argument was discovered by a contemporary of Galileo, Simon Stevin, called the ‘Dutch Archimedes’ for his prolific inventions, which included a sand yacht which beat a horse in a race along the sea shore.

Please click the advert

Are you considering a European business degree?

LEARN BUSINESS at university level. We mix cases with cutting edge research working individually or in teams and everyone speaks English. Bring back valuable knowledge and experience to boost your career.

MEET a culture of new foods, music and traditions and a new way of studying business in a safe, clean environment – in the middle of Copenhagen, Denmark.

ENGAGE in extra-curricular activities such as case competitions, sports, etc. – make new friends among CBS' 18,000 students from more than 80 countries.







See what we look like and how we work on cbs.dk

5.4 Resolving forces in two directions

In the examples so far, it has been sufficient to consider the balance of forces in a single ‘obvious’ direction – usually the direction of any actual or possible motion. But in more complex problems it is necessary to resolve forces in two separate directions.

Example 5.4

A brick rests on an inclined board, with the coefficient of friction between the brick and the board being $\mu = 0.5$. One end of the board is lifted until the brick starts to slip. What is the inclination of the plank to the horizontal when this happens?

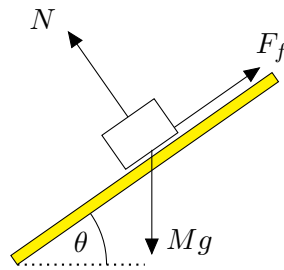

Figure 5.7: A brick on an inclined board.

Suppose that the mass of the brick is M and its weight is Mg . The brick will start to slide once the component of its weight in the direction of the slope, $Mg \sin \theta$, exceeds the limiting frictional force $F_f = \mu N$.

This condition, however, does not provide sufficient information on its own. We have first to calculate the normal reaction N . On this inclined surface, N needs to balance not the whole weight of the brick but only the component of the weight which is perpendicular to the slope. Resolving perpendicular to the slope gives

$$N = Mg \cos \theta .$$

Assuming limiting friction and going back now to the force balance parallel to the slope

$$F_f = \mu N = \mu Mg \cos \theta = Mg \sin \theta ,$$

so that

$$\mu = \tan \theta . \quad (5.1)$$

This equation for the limiting value of the angle of inclination of the board was discovered by the German mathematician Euler. For $\mu = 0.5$, the solution is $\theta = 26.6^\circ$.

Example 5.5

A kite of mass 0.5 kg is attached to a fixed point on the ground by a string of length 30 metres, and kept airborne by a lift force of 20 newtons from the wind. If the lift force

is inclined at an angle of 30° to the vertical, at what height above the ground can the kite rest in equilibrium?

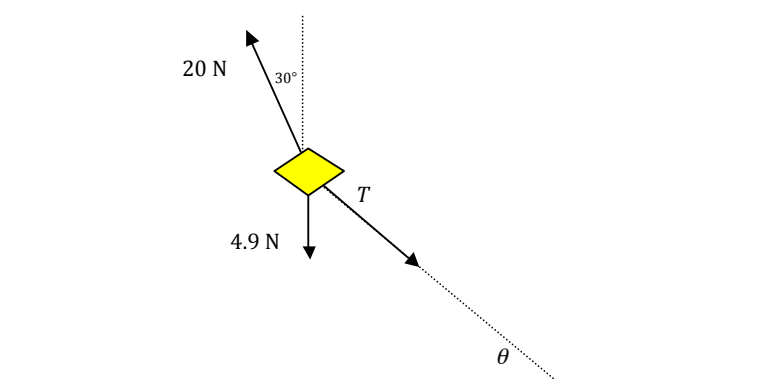

Figure 5.8: *The kite of Example 5.5.*

As in *Example 5.4*, this is a question where it is necessary to resolve forces in two directions. Suppose that the tension in the kite string is T and that the string makes an angle θ with the ground. Resolving vertically, assuming equilibrium, gives

$$T \sin \theta = 20 \cos(30^\circ) - 4.9 .$$

Resolving horizontally,

$$T \cos \theta = 20 \cos(60^\circ) .$$

Dividing the first equation by the second, to eliminate T , gives

$$\tan \theta = 1.242 .$$

Hence $\theta = 51.2^\circ$, and the height of the kite above the ground is $30 \times \sin(51.2^\circ) = 23.4$ metres.

6 Rigid bodies

6.1 Why rigid?

For many purposes we can deal with tennis balls, cars, and even planets as though they were particles, of effectively zero size. But there are instances where the particle picture is not enough. A playground see-saw would hardly be a see-saw if it did not have two ends, separated by some fixed distance. In the language of mechanics, a ‘rigid body’ is a body whose fixed size and shape are significant features of the problem at hand.

The analysis of rigid bodies involves an extra degree of complication. Potentially, we must deal with their rotation as well as with any translational motion from one point to another. The questions discussed in this chapter, however, all relate to bodies which are in equilibrium, keeping a fixed position and orientation. Problems about cricket bats or Catherine Wheel fireworks are, regrettably, beyond our scope for the present.

6.2 The lever

The law of the lever was formulated by Archimedes, generally reckoned, along with Newton and Gauss, as one of the three greatest mathematicians in history. Born in 287 BC, he lived in the town of Syracuse in Sicily, and was famous both as a mathematician and as an inventor of mechanical devices and engines of war. Of his work it was said, it is not possible to find in all geometry more difficult and intricate questions, or more simple and lucid explanations. . . no amount of investigation of yours would succeed in attaining the proof, and yet, once seen, you immediately believe you could have discovered it.

The law of the lever says that if two masses rest in equilibrium on a beam, or ‘rigid rod’, the product of the masses with their respective distances from the fulcrum are equal. In the diagram below, $m_1 \times x_1 = m_2 \times x_2$.

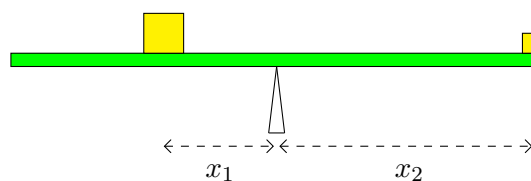

This Archimedes deduced from simple arguments of symmetry. Suppose, he said, that the masses are measured in some common unit. If the unit is m , suppose for the sake of illustration, $m_1 = 3m$ and $m_2 = 2m$. Then the total mass is $5m$, and the beam will be balanced if its length is divided into 5 equal parts with a unit mass placed at the centre of each.

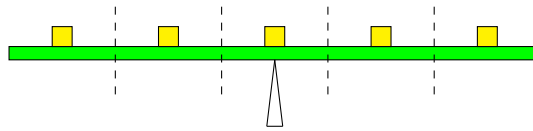

Now, without disturbing the overall balance, the three masses on the left hand side can be brought together at their common centre of gravity, as can the two masses on the right:

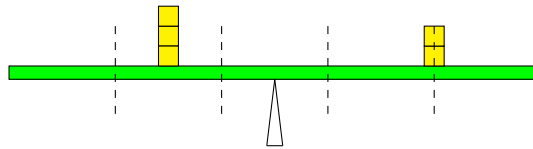

Here it is seen that the mass $3m$ on the left is positioned one unit of length from the fulcrum, while the mass $2m$ on the right is at a distance of one and half units, confirming the constancy of the product, mass \times distance.

In modern terminology, the law of the lever is expressed in terms of the ‘moments’ of the forces acting either side of the fulcrum, where the moment of a force about an axis is the product of the magnitude of the force and the perpendicular distance of its line of action from the axis. Given a fulcrum, the action of a force can be magnified if it acts at a greater distance. We meet applications of the law every day in, for example, the door handle or the bottle-opener, and also, as Newton remarked, in the operation of muscles and bones in living creatures.

Please click the advert



The financial industry needs a strong software platform

That's why we need you

SimCorp is a leading provider of software solutions for the financial industry. We work together to reach a common goal: to help our clients succeed by providing a strong, scalable IT platform that enables growth, while mitigating risk and reducing cost. At SimCorp, we value commitment and enable you to make the most of your ambitions and potential.

Are you among the best qualified in finance, economics, IT or mathematics?

Find your next challenge at
www.simcorp.com/careers



www.simcorp.com

MITIGATE RISK | REDUCE COST | ENABLE GROWTH

Example 6.1

What is the upward force U necessary to move a wheelbarrow which carries a load of 400 newtons, given the dimensions shown in the diagram below?

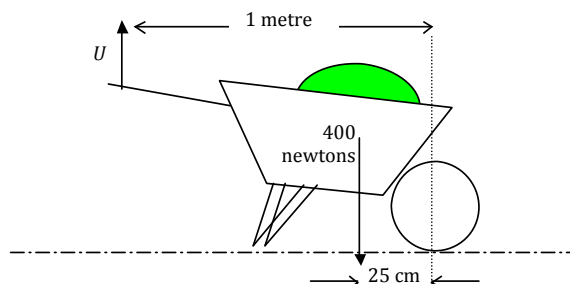

The natural fulcrum for this calculation is the point of contact of the wheel with the ground. To lift the legs of the barrow clear of the ground, the clockwise turning moment of the applied force on the handles must balance the counter-clockwise moment of the load.

$$U \times 1.00 = 400 \times 0.25 .$$

The force required is therefore $U = 100$ newtons.

6.3 Rigid bodies in equilibrium

Generally, problems about rigid bodies in equilibrium or in limiting equilibrium, on the point of movement, need three equations for their solution. Two equations come from the balance of forces in horizontal and vertical directions, or other alternative directions, just as with the analysis of a ‘particle’. The third equation comes from taking moments. The principle is that in equilibrium the sum of the moments is zero. The centre for the moments calculation can be chosen to make the equation as simple as possible – there is no requirement that it should be a natural fulcrum for the problem.

Example 6.2

A shelf 2 metres long, supported by brackets at its two ends L and R, carries a set of encyclopædias of total weight 100 newtons. The volumes occupy a one metre length of the shelf at the left hand end. What are the loads F_L and F_R on the two brackets?

We shall ignore the weight of the shelf itself and suppose that the weight of the books acts through their geometric mid-point. There is no natural pivot here but we can choose to take moments about, say, the left hand end of the shelf, L. Then

$$100 \times 0.5 = F_L \times 0 + F_R \times 2 ,$$

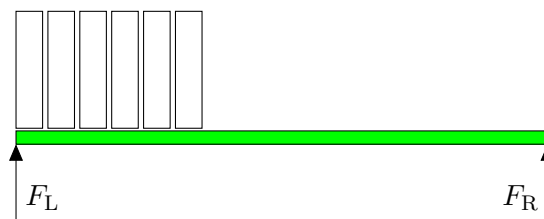

and $F_R = 25$ newtons. We notice how the decision to take moments about L eliminates from the resulting equation the force F_L which acts through L. This is a general principle and a very valuable trick for arriving at simple equations.

Having now calculated F_R , it follows that $F_L = 75$ newtons since the sum $F_L + F_R$ must equal the total weight of the books.

Example 6.3

Farmer G is pushing (in a horizontal direction) on a cube-shaped bale of straw, of size $1\text{ m} \times 1\text{ m} \times 1\text{ m}$ and weight 500 newtons. Calculate the force F required to make the bale start to turn over.

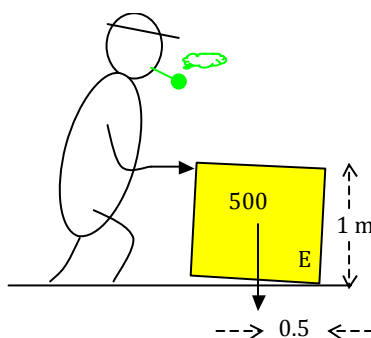

When the bale turns, it will rotate initially about the edge E. The clockwise moment of F about E must overcome the anticlockwise moment of the weight, acting through the centre of gravity. It does not matter that one force is vertical, the other horizontal. “Force \times perpendicular distance” applies just the same. Thus $F \times 1 = 500 \times 0.5$, and the force required is 250 newtons.

The supplementary question which arises in this situation is how rough the ground needs to be to stop the bale from sliding away from G as he tries to rotate it. To consider this we need to consider the forces on the bale more carefully. In addition to the weight of the bale and the applied force F , we must include the normal reaction force N from the ground on the bale and the friction force F_f .

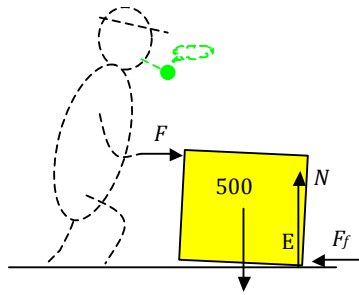

Considering the equilibrium situation just before the bale moves, resolving forces horizontally and then vertically tells us

$$F_f = F = 250 \text{ newtons} , N = 500 \text{ newtons} .$$

Since $\mu \geq F_f/N$, the minimum coefficient of friction between the bale and the ground must be 0.5. Notice that as F_f and N act at E, they don't contribute to moments about E.

Please click the advert

What do you want to do?

No matter what you want out of your future career, an employer with a broad range of operations in a load of countries will always be the ticket. Working within the Volvo Group means more than 100,000 friends and colleagues in more than 185 countries all over the world. We offer graduates great career opportunities – check out the Career section at our web site www.volvogroup.com. We look forward to getting to know you!

VOLVO
AB Volvo (publ)
www.volvogroup.com

VOLVO TRUCKS | RENAULT TRUCKS | MACK TRUCKS | VOLVO BUSES | VOLVO CONSTRUCTION EQUIPMENT | VOLVO PENTA | VOLVO AERO | VOLVO IT
VOLVO FINANCIAL SERVICES | VOLVO 3P | VOLVO POWERTRAIN | VOLVO PARTS | VOLVO TECHNOLOGY | VOLVO LOGISTICS | BUSINESS AREA ASIA

Download free ebooks at bookboon.com

Example 6.4

A ladder of length 6.5 m and weight 200 N rests against a wall with its base on rough ground 2.5 m away from the bottom of the wall. The wall is perfectly “smooth” so the reaction R from the wall on the ladder is exactly perpendicular to the wall. What is the minimum value of μ , the coefficient of friction between the ground and the ladder, for the ladder to remain in equilibrium in this position?

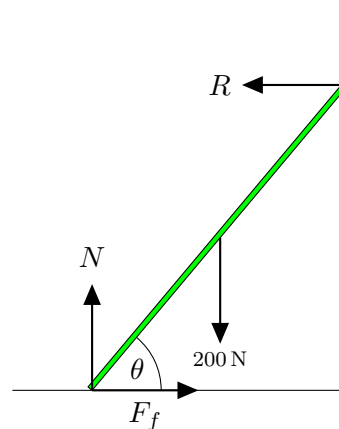

Figure 6.1: *The ladder of Example 6.4 resting against a wall.*

Let θ be the angle the ladder makes with the horizontal. From the dimensions given, $\cos \theta = 2.5/6.5 = 5/13$, and θ is an angle in a 5, 12, 13 Pythagorean triangle with $\sin \theta = 12/13$, $\tan \theta = 12/5$. The simplest moment balance comes from taking moments about the base of the ladder, which will eliminate both N and F_f from the resulting equation. Assuming the centre of gravity of the ladder to be at its mid-point, and balancing the moment about B of the ladder’s weight with the moment of the reaction at the wall, R

$$200 \times \frac{1}{2} \times 6.5 \cos \theta = R \times 6.5 \sin \theta ,$$

giving $R = 200 \times 1/2 \times 5/12 = 41\frac{2}{3}$ newtons. And, resolving vertically and horizontally,

$$N = 200 \text{ newtons} , F_f = R = 41\frac{2}{3} \text{ newtons} .$$

Since $\mu \geq F_f/N$, the limiting value for μ is $41\frac{2}{3} \div 200 = 5/24$, about 0.21.

Example 6.5

If, in *Example 6.4*, the actual value of μ is 0.35, how far up the ladder could Mr B climb before it starts to slip, if his weight is 800 N?

This looks a more complicated problem than *Example 6.4*, but the same equations apply. We need only to add in the extra contribution of Mr B. If he climbs a distance x up the ladder, the moments equation becomes (see *Figure 6.2*)

$$0.5 \times 200 \times 6.5 \cos \theta + 800 \times x \cos \theta = R \times 6.5 \sin \theta .$$

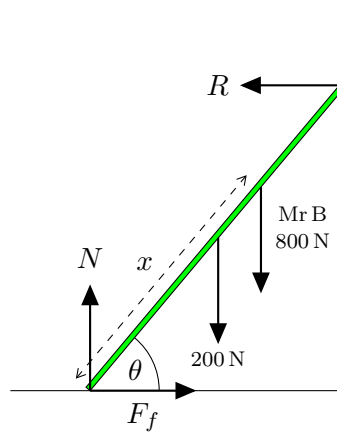

Figure 6.2: *Mr B, weight 800 N, climbs up the ladder.*

The horizontal force balance is unchanged

$$F_f = R ,$$

while resolving vertically

$$N = 200 + 800 = 1000 .$$

Now put $R = F_f = \mu N = 0.35 \times 1000 = 350$ in the moments equation to find the limiting value of x ,

$$x = \frac{(6.5 \times 350 \tan \theta - 0.5 \times 200 \times 6.5)}{800} ,$$

giving $x = 6.01$ metres. The ladder would therefore slip just before Mr B reaches the top.

Example 6.6

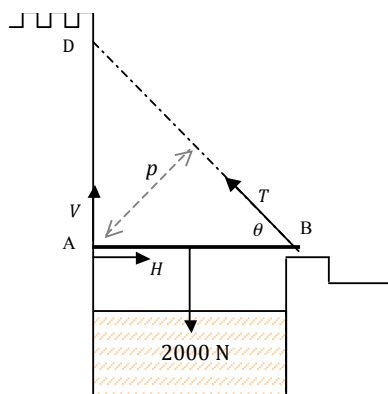

Figure 6.3: *The castle, moat and drawbridge of Example 6.6.*

Castle C is surrounded by a moat M. Entrance to the castle is by means of a drawbridge AB, which is 4 m long when lowered and is hinged at A, at the bottom of the castle walls. The bridge is raised and lowered by means of a chain attached to the far end of the bridge

B which passes over a pulley at a point D 4.2 m directly above A. If the weight of the bridge is 2000 N, calculate (a) the tension in the chain needed to lift the bridge from its horizontal resting position and (b) the vertical and horizontal components of the force exerted by the bridge on the hinge at A.

(a) Consider the equilibrium of the bridge and equate the anti-clockwise turning moment about A of the cable tension T with the clockwise moment of the weight. Then, if p is the perpendicular distance from A to the cable BD,

$$T \times p = 2000 \times \frac{1}{2}AB .$$

To calculate p , notice that the area of the triangle ABD can be calculated either by taking AB as the base, and AD as the height, or taking BD as the base, and p as the height. Since both routes must lead to the same answer, $p = (AB \times AD)/BD$. Substituting for p in the moments equation

$$T = 2000 \times \frac{1}{2}AB \times \frac{BD}{AB \times AD} = 1000 \times \frac{BD}{AD} = 1381 \text{ newtons.}$$

(b) Again, since the bridge is in equilibrium the horizontal force H from the hinge must balance the horizontal component of the cable tension,

$$H = T \cos \theta = T \frac{AB}{BD} = 952 \text{ newtons.}$$

Please click the advert

RedStarResume

Do you want your Dream Job?

More customers get their dream job by using RedStarResume than any other resume service.

RedStarResume can help you with your job application and CV.

**Go to: Redstarresume.com
Use code "BOOKBOON" and save up to \$15**

(enter the discount code in the "Discount Code Box")



(c) Similarly, the vertical force V , together with the vertical component of the tension, must balance the weight of 2000 newtons, giving

$$\begin{aligned} V + T \sin \theta &= 2000 \\ \Rightarrow V &= 2000 - T \sin \theta = 2000 - T \frac{AD}{BD} = 1000 \text{ newtons.} \end{aligned}$$

V and H are forces on the bridge from the hinge. The forces on the hinge will, by Newton's third law, be equal and opposite, that is 952 newtons into the wall, and 1000 newtons downwards.

A hidden assumption in all the calculations here is that the weight of the chain is small compared with the weight of the bridge. A more realistic chain would sag under its own weight, modifying the geometry of the triangle ABD and the equations we have derived from it.

Example 6.7

A suspension bridge has a span of 100 metres and the deck, which weighs 200 tonnes, hangs from cables fixed to piers on either side. The cable fixing points are 20 metres above the level of the deck. Assuming that the weight of the cables is small compared with the weight of the deck, calculate the tension in the cables (a) at the centre of the span and (b) at the fixing points.

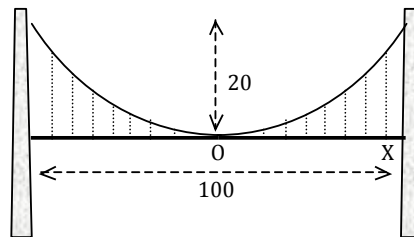
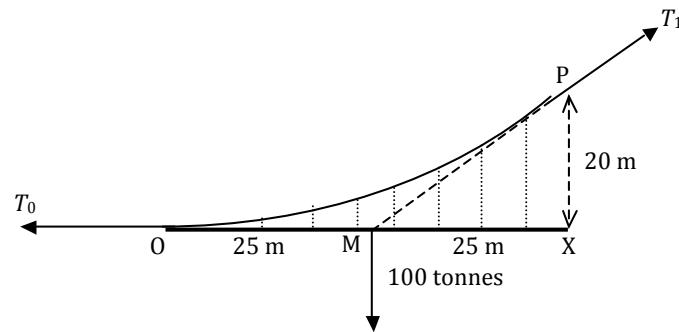

Figure 6.4: A suspension bridge with a span of 100 m and a deck-weight of 200 tonnes.

Consider the right hand half of the bridge – including the deck and cables, but excluding the pier – as a single body shown in *Figure 6.5*. It is subject to three forces: its own weight, 100 tonnes, acting through the mid-point M of the half-span OX, the horizontal force from the tension in the cable T_0 at the centre of the span, and the oblique force T_1 at the cable attachment point P. To ensure the overall balance of forces, the vertical and horizontal components of T_1 must be equal to the weight 100 tonnes and the horizontal tension T_0 .

A further requirement for equilibrium is that the combined turning moment of these three forces must be zero. The lines of action of both the deck weight and the horizontal tension T_0 both pass through M, giving zero turning moment. To ensure zero moment from all three forces, the line of action of the third force T_1 must also pass through M. To satisfy the geometry, its vertical and horizontal components must have the same ratio

Figure 6.5: *The right hand half of the bridge.*

as the sides PX and MX of the triangle PMX, so

$$\frac{100 \text{ tonnes}}{20 \text{ m}} = \frac{T_0}{25 \text{ m}},$$

and $T_0 = 125$ tonnes. And then, combining vertical and horizontal components,

$$T_1 = \sqrt{(125^2 + 100^2)} \approx 160 \text{ tonnes.}$$

The same kind of analysis can be applied, not only to the half-span, 50 metres long, but to any segment of the bridge, with length x measured outwards from the centre of the span. Then, in the equation for T_0 above, the length 25 metres is replaced by $\frac{1}{2}x$, the weight 100 tonnes becomes $2x$, pro rata with segment length, and the height 20 metres is replaced by y , the height of the cable above the deck at a distance x from the centre. The tension T_0 itself is now known to be 125 tonnes. Then

$$\frac{2x}{y} = \frac{125}{x/2},$$

or, expressing height y as a function of position x

$$y = \frac{x^2}{125}.$$

If the cables are light compared with the deck, they follow a parabolic profile.

7 Centres of gravity

7.1 Using symmetry

In the examples of *Chapter 6*, we have assumed that the weights of objects like a straw bale or ladder act at centres of gravity which we take to be at their geometric centres. For rods and rectangles, cubes and circles, and many other shapes, the centre of gravity is obvious from the symmetry. Where they apply, arguments from symmetry are very pleasing and economical.

Example 7.1

Mr B, constructing a shop sign, wishes to determine the centres of gravity of large letters F, I, S, H, cut out from rectangular sheets of uniform density. He concludes that, because of symmetry, the centres of gravity for the letters I, S, H, must lie at the centre of their respective rectangles.



7.2 Archimedes' calculations

Archimedes devised elegant geometrical arguments to find the centre of gravity of other shapes – the cone, the hemisphere, and the parabolic section – where symmetry alone is not sufficient. *Example 7.2* shows how he calculates the centre of gravity of a uniform triangle (technically called a triangular lamina, after the Latin word for a sheet).

Example 7.2

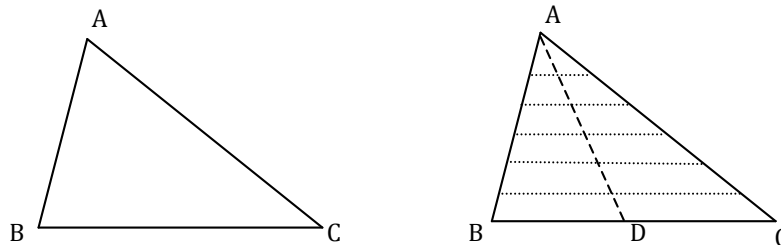

Suppose the triangle is ABC. We may imagine it divided into a large number of thin strips, parallel to BC. Each of these strips is, approximately, a rectangle (though Archimedes' exact argument takes care of the left over corners as well), and their individual centres of

gravity will all lie on the median AD, the line joining the vertex A to the mid-point D of the opposite side BC. Their combined centre of gravity, therefore, which is the centre of gravity G of the whole triangle, will also lie on AD. By a similar argument, considering strips parallel to AC or AB, G lies also on the medians through B and C, and therefore at their common point of intersection, called the centroid.

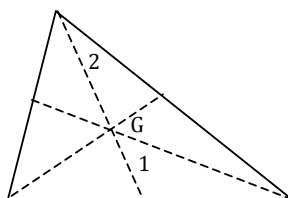

From Euclid's geometry, or by a simple vector calculation, it is known that the centroid divides each of the medians in a ratio 2 : 1, so that the height of the centre of gravity above the base of the triangle is one third of the height of the triangle.

Try this...



The sequence 2, 4, 6, 8, 10, 12, 14, 16, ... is the sequence of even whole numbers. The 100th place in this sequence is the number...?

Challenging? Not challenging? Try more >>

www.alloptions.nl/life

Please click the advert

7.3 Combining shapes

Centres of gravity for more complex shapes can be found by dividing them into two or more simpler shapes with known centres of gravity, and if necessary applying a calculation based on the principle of the lever.

Example 7.3

A dart is made from a square piece of paper, $24\text{ cm} \times 24\text{ cm}$. As a first step, corners A and B of the square are folded over to meet at the centre C. Where is the centre of gravity G of the folded sheet?

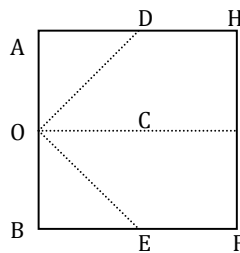

From the symmetry, the centre of gravity will lie on the centreline of the paper, OC, so it is only necessary to calculate the distance of G from AB. Once the paper has been folded, we can look at it as made up of two parts, one being the rectangle DEFH, and the other the double-thickness triangle ODE. The centre of the rectangle is 18 cm from O and the centre of gravity of the triangle is $\frac{2}{3} \times 12 = 8\text{ cm}$ from O. The masses of the rectangle and of the triangle are equal, both being one half the mass of the unfolded sheet, and so their combined centre of gravity is at the mid-point, 13 cm from O.

Example 7.4

Mr B, constructing a shop sign, wishes to determine the centres of gravity of large letters F, I, S, H, cut out from rectangular sheets of uniform density. He has concluded that, because of symmetry, the centres of gravity for the letters I, S, H, must lie at the centre of their respective rectangles. But where is the centre of gravity for F?

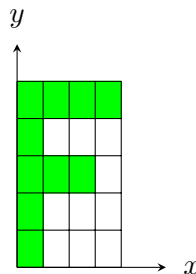

For convenience, let us take an origin at the bottom left hand corner and suppose that the centre of gravity is at the point (\bar{x}, \bar{y}) . The complete letter F can be regarded as

consisting of three parts, a stem, measuring 5 units high by 1 unit wide, a top branch, 1 unit by 3 units, and the lower branch, 1 unit by 2 units. These parts are all rectangular, and we know therefore their centres of gravity. To calculate \bar{x} , the rule is that the whole mass of the letter, which is $5 + 3 + 2 = 10$ mass units, when placed at a distance \bar{x} from a knife-edge fulcrum running along the y -axis, should have the same turning effect about the axis as the separate masses of the component parts, located at their individual centres of gravity. The co-ordinate \bar{y} is similarly found by consideration of the turning moments about the x -axis.

A good way to set out this type of centre of gravity calculation is to make a table. Here, we will have four columns, three for each of the component parts of the “F” and one for the whole letter. Apart from the labels, the first row contains the masses “ m ” of the various parts, which in this case are pro rata with their areas. The second row “ x ” contains the co-ordinates of the centres of gravity. For the component parts these are known values, and for the whole letter F we write \bar{x} . Finally the third row is the product “ mx ” of the first row and the second – effectively the turning moment about the y -axis.

	vertical stem	upper branch	lower branch	complete letter
m	5	3	2	10
x	0.5	2.5	2	\bar{x}
mx	2.5	7.5	4	$10\bar{x}$

Table 7.3: Table for calculating the “ x ” centre of gravity, \bar{x} .

Equating the turning moments in the last row,

$$2.5 + 7.5 + 4 = 10\bar{x} ,$$

so that $\bar{x} = 1.4$ units. By a similar calculation, $\bar{y} = 3.1$ units.

7.4 Hanging from a fixed point

When a rigid body hangs freely from a fixed point, the centre of gravity will lie directly beneath the point of suspension.

Example 7.5

A uniform rectangle ABCD is cut out of a sheet of metal. $AB = 40$ cm and $BC = 20$ cm. The rectangle is suspended by a thread which is attached at a point X on AB such that $AX = 30$ cm. When the rectangle hangs in equilibrium, what is the angle between AB and the vertical?

Here we are invited to find the angle which AB makes with the known vertical XG. In such questions, in addition to sketching the suspended object ‘as is’, it can be helpful to

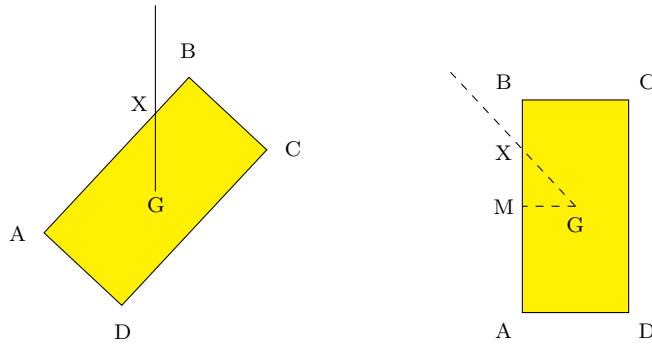

Figure 7.1: The rectangle ABCD in both its suspended orientation ‘as is’ (left) and its ‘natural’ orientation (right).

draw a second diagram, with the object in its ‘natural’ orientation with its sides parallel to the usual x - and y -axes. The required angle is the same in both diagrams, but more easily calculated, perhaps, when viewed in the ‘natural’ orientation. In this example, if M is the mid-point of AB, then with the dimensions given $AM = 20$ cm, $AX = 30$ cm, $XM = 10$ cm. And $MG = \frac{1}{2}BC = 10$ cm. Triangle XMG is therefore isosceles and the required angle AXG is 45° .

Please click the advert

You’ve applied to your University...

Now Choose Your Bed!

Nido has some great options left! Live in one of our **twin studios in Nido King’s Cross** or **two bedroom studios in Nido Spitalfields**.

Nido is the newest way of living student life in central London. It’s not just a residence, it’s a way of living that we call ‘Nidology’.

Book your room and we will reward you with a £50 voucher from www.voucherepress.co.uk voucher* to spend in London shops! To enter, make a booking with Nido online using the promotional code ‘Bookboon01.’ For terms and conditions, please visit:

www.NidoStudentLiving.com/Bookboon

WIN a £50 Voucher with every booking!

Nido

Example 7.6

The letter F of *Example 7.4* hangs freely from a nail at the top left hand corner T. What then is the angle between the left hand edge of the letter, OT, and the vertical?

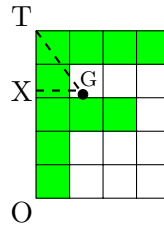

When the letter hangs freely, the centre of gravity G lies below the point of suspension, and in the diagram the ‘as is’ vertical GT is superimposed on the letter F in its conventional upright form. If XG is drawn from G perpendicular to OT, the angle between OT and GT can be determined from the geometry of the triangle GTX. Here, using the results of *Example 7.4*, $XG = \bar{x} = 1.4$ units, $TX = 5 - \bar{y} = 1.9$ units. If, as drawn above, the units are in fact square (rather than the more general case of rectangular units) so that one x -unit is equivalent to one y -unit, the required angle GTX is $\arctan(14/19) = 36^\circ$.

Example 7.7

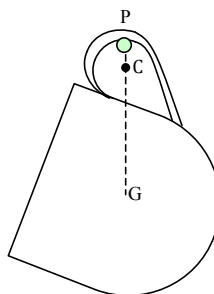

Imagine a tea cup, hanging from a peg P. The handle has a circular profile with a centre at C. The weight of the cup acts at the centre of gravity G, which must lie vertically below the point of support at the peg. Equilibrium is maintained by an equal and opposite vertical reaction at the peg. If the peg is smooth (no friction), this reaction must be perpendicular to the curve of the handle and its line of action must pass through the centre of curvature at C. The radius CP is therefore vertical and the cup must hang so that P, C and G are all in the same vertical line.

By visualising a circle, centred at G, which passes through P, we see that the cup must slide on the peg until in its resting position GP is a maximum, so that G is as far below P as possible.

7.5 Stability

A rigid body resting on an inclined surface will topple if the vertical line through the centre of gravity passes outside the ‘footprint’ of its base.

Example 7.8

A golf ball of radius 21 mm sits on a tee peg whose cup is of radius 5 mm. At what angle to the vertical must the peg have been placed in the ground if it is so crooked that the ball falls off?

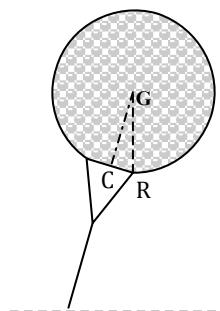

In the diagram, C is at the centre of the cup, in the plane of its rim. G is the geometric centre of the ball and also its centre of gravity. CG lies along a radius of the ball and is in line with the shaft of the peg. At the limiting angle, the vertical line down from G passes just within the rim at R. The required angle, therefore, is the angle CGR. CR is perpendicular to CG, and angle $CGR = \arcsin(CR/GR) = \arcsin(5/21) = 14^\circ$.

Please click the advert

THIS **ebook** IS PRODUCED WITH **iText**®

Download free ebooks at bookboon.com

8 Momentum

8.1 Momentum

In ordinary language, *momentum* is what makes a moving object hard to stop. The more massive the object, and the greater its speed, the larger is its momentum. For a mass m , travelling with velocity v , the momentum is given by the simple formula mv . Since mass is measured in kg, and velocity in m/s, the unit of momentum is kg m s^{-1} . Alternatively – we shall see why in *Section 8.4* – the equivalent form N s, standing for newton-seconds, is used.

8.2 Conservation of momentum

The formula, momentum equals mv , does more than just introduce another a piece of terminology. Momentum, so defined, obeys a far-reaching law, the law of conservation of momentum.

To illustrate, consider two astronauts, floating in space, facing each other, and both having zero velocity. A has mass 100 kg and B has mass 80 kg. A now pushes B, exerting a force of 20 newtons for a period of 1 second. According to Newton's second law, B now accelerates away from A, the acceleration being $a = F/m = 20/80 = 0.25 \text{ m/s}^2$. After 1 second, B has velocity $0.25 \times 1 = 0.25 \text{ m/s}$ and his momentum is $80 \times 0.25 = 20 \text{ N s}$.

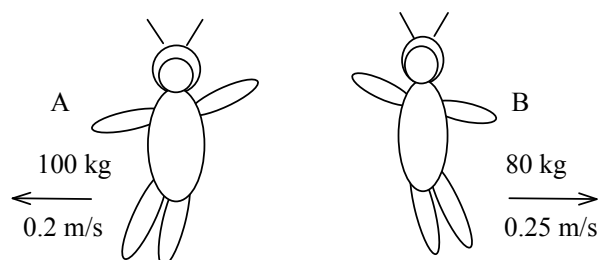

According to Newton's third law, A, while pushing B, is himself subject to a reaction force of 20 newtons in the opposite direction. His acceleration is $a = -20/100 = -0.20 \text{ m/s}^2$, where the minus sign indicates that the acceleration is in the opposite direction to B's. After 1 second, A has velocity -0.20 m/s and his momentum is $100 \times -0.20 = -20 \text{ N s}$.

In the absence of any other forces, A and B will now continue to drift apart, but their total momentum will remain zero, just as it was initially, when both had zero velocity.

The general principle is that the total momentum of any isolated system, not subject to any external forces, remains constant. This is the law of conservation of momentum

(LOCOM). The internal forces in the system may be as complex as you would care to imagine – astronaut A may push B again, or throw things at him, or throw him a line and pull him back in – but, so long as there are no forces from outside, the total momentum is unchanged.

8.3 Collisions and explosions

In actuality, the universe functions as a whole. Truly isolated systems, for which momentum is exactly conserved, are hard to find. But some situations can be regarded as nearly isolated, for the purposes of calculation. In a collision, for example, when car A hits bus B, the forces of A and B on each other during the brief duration of the actual impact are much larger than the external forces such as frictional forces from the road surface.

Likewise, when a Bonfire Night rocket reaches the apex of its flight, to burst into a cluster of stars, the cluster at first radiates symmetrically, and the individual momenta of the separate parts total to the momentum of the rocket just before it exploded. Over a longer time scale the effects of the external force of gravity come into play and the cluster moves predominantly downwards, losing its initial symmetry.

In a collision, then, or an explosion, the total momentum immediately after the impact or explosion can be assumed equal to the total momentum just beforehand. If two colliding masses m_1 and m_2 have velocities u_1 and u_2 before impact, and v_1 and v_2 afterwards, the law of conservation of momentum takes the easy-to-remember form

$$m_1u_1 + m_2u_2 = m_1v_1 + m_2v_2 . \quad (8.1)$$

Example 8.1

Particle A, mass 1 kg, and travelling at 5 m/s, collides head-on with particle B, mass 2 kg which is at rest. After the collision B moves away at 3 m/s. What is the velocity of A?

	A	B
Before:	①	②
	5 m/s →	0 m/s
After:	①	②
	v m/s →	3 m/s →

$$\begin{aligned}
 & \text{“}m_1u_1 + m_2u_2 = m_1v_1 + m_2v_2\text{”} \\
 \Rightarrow & (1 \times 5) + (2 \times 0) = (1 \times v) + (2 \times 3) \\
 \Rightarrow & v = -1 .
 \end{aligned}$$

The speed of A after the collision is therefore 1 m/s. The minus sign indicates that its direction of motion has been reversed. The mathematician understands a velocity of -1 m/s, travelling to the right, to mean 1 m/s, travelling to the left.

Example 8.2

A railway truck A, travelling at speed 6 m/s, collides with a similar truck B. After the collision the two trucks couple together and move off before hitting a third truck C. Finally, the three trucks move off together down the track. What is their common speed?

We do not know the mass of the trucks, but if they all have the same mass we can suppose that this is M . Then the principle “momentum before equals momentum after” can be expressed as

$$(M \times 6) + 0 + 0 = (3M) \times v .$$

The factor M cancels and v , the final speed which was to be determined, comes out at 2 m/s.

Notice that we need not be concerned, unless we are interested, with the details of the intermediate state when A has hit B but C is still at rest. The conservation law allows us to link directly the initial and the final states, by-passing whatever happens in between. This can greatly simplify the calculation.

Please click the advert

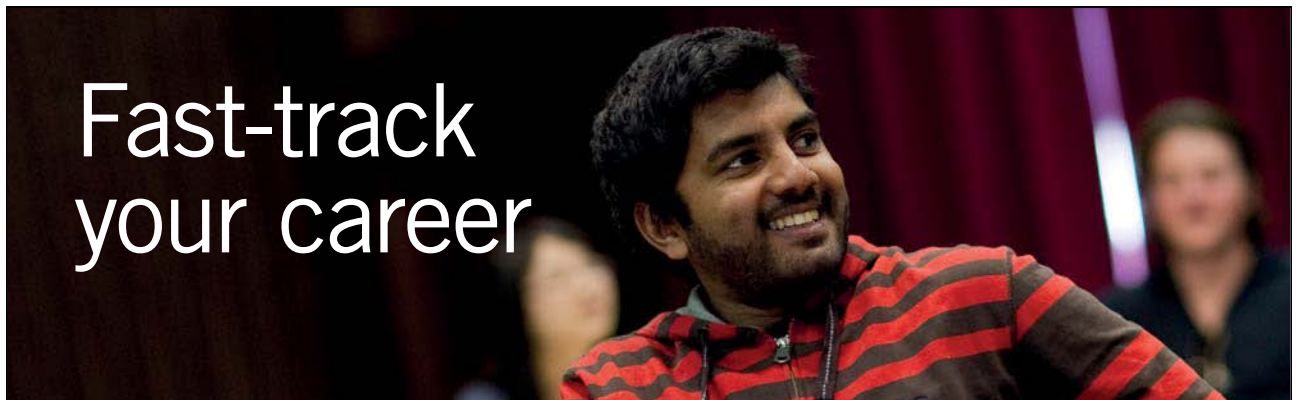

Fast-track your career

Masters in Management



London Business School
Regent's Park
London NW1 4SA
United Kingdom
Tel +44 (0)20 7000 7573
Email mim@london.edu
www.london.edu/mim/

Stand out from the crowd

Designed for graduates with less than one year of full-time postgraduate work experience, London Business School's Masters in Management will expand your thinking and provide you with the foundations for a successful career in business.

The programme is developed in consultation with recruiters to provide you with the key skills that top employers demand. Through 11 months of full-time study, you will gain the business knowledge and capabilities to increase your career choices and stand out from the crowd.

Applications are now open for entry in September 2011.

For more information visit www.london.edu/mim/
email mim@london.edu or call +44 (0)20 7000 7573

8.4 Impulse

An impulse is what sets an object moving, giving it momentum. In the same way, an impulse, acting on a body of mass m which is already moving, can produce a change in momentum. So the formula for impulse I is

$$I = mv - mu, \quad (8.2)$$

where u is the initial velocity and v is the final velocity of the mass m .

There is also a second formula for impulse which refers more directly to the impelling force, rather than the impelled object. Suppose that the body is accelerated from initial speed u to final speed v in a time t seconds. If the acceleration a is presumed constant, then

$$v = u + at.$$

Our first formula for impulse, $I = mv - mu$, is equivalent to

$$I = m(u + at) - mu = mat.$$

From Newton's second law, $F = ma$, so that the alternative formula for impulse is

$$I = Ft. \quad (8.3)$$

Since force F is measured in newtons, and duration t in seconds, the formula shows how it is that impulse and momentum can be expressed in units of N s, as well as kg m s^{-1} .

Example 8.3

In *Example 8.1* above, what are the impulses received by the two particles?

	A	B
Before:	①	②
	5 m/s →	0 m/s
After:	①	②
	1 m/s ←	3 m/s →

For A

$$I = mv - mu = (1 \times -1) - (1 \times 5) = -6 \text{ N s}.$$

For B

$$I = mv - mu = (2 \times 3) - (2 \times 0) = 6 \text{ N s}.$$

The impulses on A and B are equal in magnitude but in opposite directions. This is a consequence of Newton’s third law. Although the calculation for A gives a negative answer, we would often just state its magnitude. It is after all fairly obvious that when A, travelling to the right in what we have chosen to call the positive direction, runs into the obstacle which is particle B, it will receive an impulse in the reverse direction, towards the left.

Example 8.4

Mr C of mass 60 kg dives off a stationary boat of mass 150 kg. If he pushes off with a horizontal impulse of 90 N s, what is his forward speed on hitting the water?

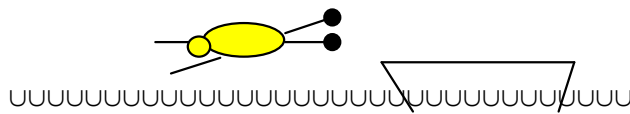

From Newton’s third law, Mr C exerts an impulse of 90 N s on the boat and the boat must exert an equal and opposite impulse 90 N s on Mr C. If Mr C acquires a forward speed V m/s, his gain in momentum, from an initially stationary position, will be $60V$ N s and this must equal the impulse exerted by the boat of 90 N s. So $V = 1.5$ m/s. The boat, of mass 150 kg, will meanwhile be pushed in the opposite direction with speed $90/150 = 0.6$ m/s.

Please click the advert



You’re full of *energy*
and *ideas*. And that’s
just what we are looking for.

Looking for a career where your ideas could really make a difference? UBS’s Graduate Programme and internships are a chance for you to experience for yourself what it’s like to be part of a global team that rewards your input and believes in succeeding together.

Wherever you are in your academic career, make your future a part of ours by visiting www.ubs.com/graduates.

www.ubs.com/graduates



© UBS 2010. All rights reserved.

Example 8.5

A hose 2 cm in diameter delivers 75 litres of water per minute. If the water jet is directed perpendicularly against a wall, calculate the force exerted.

75 litres of water per minute is equivalent to a flow of 1.25 litres per second, or 1.25×10^{-3} cubic metres per second, or, in terms of mass, $M = 1.25$ kg per second as the density of water is $\rho_{\text{H}_2\text{O}} \approx 1000 \text{ kg m}^{-3}$. If the water flow speed is V m/s, the volume of water discharged in one second is equivalent to a cylinder of length V metres and cross-sectional area $\pi \times 0.012$ sq. m, so that

$$\text{flow rate} = V \times \pi \times 0.012 = 1.25 \times 10^{-3} ,$$

and $V \approx 4$ m/s. Consider now a time interval of one second, during which the momentum lost by the water hitting the wall is

$$\text{mass} \times \text{change in velocity} = MV = 1.25 \times V = 5 \text{ N s} .$$

This must be equal to the backwards impulse $I = Ft$ exerted on the water in the 1 second time interval, which by Newton's third law is equal and opposite to the impulse experienced by the wall. Since $t = 1$, the force F on the wall comes out as 5 newtons.

8.5 Duration of impact

In practice, it may be hard to determine the precise duration of impact when a ball hits the floor or a car hits a tree. However, in the formula $I = Ft$, it is the product of force and duration which matters, not their individual magnitudes. The effect of a force F acting for a time t is the same as that of a force $2F$ acting for a time $\frac{1}{2}t$. The impulse I summarizes the total effect of the impact, regardless of the uncertainties about its duration.

Example 8.6

Mr B playing tennis receives Mr C's service travelling at 30 m/s and returns the ball (mass 58 g) at a speed of 25 m/s. Calculate the impulse received by the ball. If the ball is in contact with the strings of B's racket for a period estimated as 6 ms, calculate also the average force applied to it in this time interval.

Using the formula $I = mv - mu$

$$I = 0.058 \times (25 - (-30)) = 3.19 \text{ N s} .$$

Using $I = Ft$

$$\begin{aligned} I = 3.19 &= F \times 0.006 \\ \Rightarrow F &= 531.7 \text{ N} . \end{aligned}$$

The impulse on the ball is therefore 3.2 N s and the average force applied to the ball is about 530 N (the precision of the data for this question does not justify giving answers to more than 2 significant figures).

8.6 Coefficient of restitution

Newton studied collisions using a device which has come to be known as his ‘cradle’.

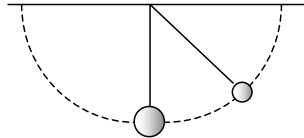

Balls of different sizes and mass could be drawn aside and released from different positions, so allowing a range of different impacts to be observed, while velocities after impact could be inferred by observing the height to which the balls rebounded.

As well as confirming the conservation of momentum in the collisions, Newton discovered another relationship linking the velocities before and after impact. Over a range of different speeds of impact, the relative velocity of the balls, just after impact, was – to a close level of approximation – proportional to the relative velocity just prior to impact. That is to say

$$\text{separation speed} = e \times \text{approach speed} , \quad (8.4)$$

where e , called the coefficient of restitution, is a constant which remains the same for all collisions between the same two bodies. Newton experimented with a range of different materials, finding values of e close to 1 for hard materials like glass or steel, and lesser values with cork or compressed wool.

The same rule is found to apply to the impact of a ball with a rigid surface, such as a floor or a wall. In this case, clearly, the speeds of the ball before and after impact are one and the same with the speeds relative to the fixed floor.

Example 8.7

	A	B
Before:	①	②
	5 m/s →	0 m/s
After:	①	②
	1 m/s ←	3 m/s →

In *Example 8.1* above, particle A collides at speed 5 m/s with a stationary particle B, rebounding with speed 1 m/s, while B moves off with speed 3 m/s in the direction of A's original motion.

The approach speed in this collision is 5 m/s, while the separation speed is $(3+1) = 4$ m/s. For A and B, therefore, $e = 4/5$.

Example 8.8

Snooker ball C travelling at speed 0.5 m/s, collides head-on with an identical stationary ball D, the coefficient of restitution being $e = 0.96$. What are the velocities after impact?

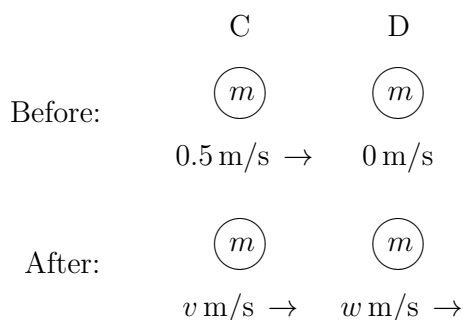

Please click the advert

© Inter IKEA Systems B.V. 2009

It's only an opportunity if you act on it

IKEA.SE/STUDENT











We suppose the mass of the balls is m , and call the unknown velocities of C and D after impact v m/s and w m/s respectively. To find v and w , two equations are available, the momentum equation

$$0.5m = mv + mw ,$$

and the equation for the coefficient of restitution

$$0.5e = 0.48 = w - v .$$

Cancelling the factor m in the momentum equation, and solving simultaneously, shows that after impact the cue ball C has velocity 0.01 m/s, while the object ball D moves off with velocity 0.49 m/s.

Collisions in the special case when $e = 1$ are called perfectly elastic. For our snooker balls, the solution with $e = 1$ is $v = 0$ m/s, $w = 0.5$ m/s. Collisions between snooker balls are indeed nearly perfectly elastic, and after a head-on impact, the object ball carries off most of the momentum while the cue ball is almost brought to rest, as is commonly observed. More comprehensive calculations would need to take into account any spin imparted to the cue ball and also the brief period of skidding by which the rolling motion of the balls adjusts, after impact, to the changes in translational speed.

Example 8.9

The specification for Wimbledon tennis balls requires that a ball dropped from a height of 100 inches (254 cm) onto a concrete surface should rebound to a height of not less than 53 inches and not more than 58 inches. Deduce the equivalent limits on the coefficient of restitution.

From the constant acceleration formula $v^2 = u^2 + 2as$, the impact speed of a ball dropped from a height H is $v = \sqrt{2gH}$. This is the approach speed. Likewise, if it rebounds to a height h , the speed at which it leaves the ground is $\sqrt{2gh}$, and this is the separation speed. The coefficient of restitution is therefore the ratio $\sqrt{2gh} : \sqrt{2gH}$, or $e = \sqrt{h/H}$, and lies between limits $\sqrt{53/100}$ and $\sqrt{58/100}$, or 0.73 and 0.76.

Example 8.10

A tennis ball is dropped from a height of 2.5 metres on to a level surface and bounces repeatedly until it comes to rest. The coefficient of restitution is $e = 0.75$. For how long does the bouncing motion continue?

The time taken to reach the floor for the first time can be found from the formula $s = ut + \frac{1}{2}at^2$. With $s = 2.5$, $u = 0$, $a = 9.8$, we find that $t_1 = 5/7$ seconds.

Compared with the original drop height, the second bounce is lower by a factor $e^2 = 9/16$, and the time of flight is reduced by a factor $e = 3/4$. The additional time taken to reach the floor for the second time, allowing for both the upward and the downward journeys, is $t_2 = 2 \times (3/4) \times (5/7)$. The time for the third bounce is similarly reduced by a further

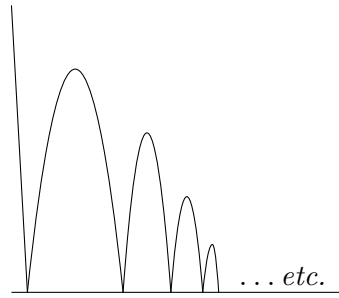

Figure 8.1: A tennis ball bouncing on a level surface.

factor $e = 3/4$, $t_3 = 2 \times (3/4)^2 \times (5/7)$. For the fourth bounce, $t_4 = 2 \times (3/4)^3 \times (5/7)$, and so on.

The total time is the sum

$$T = t_1 + t_2 + t_3 + t_4 + \dots = \frac{5}{7} \times \left[1 + 2 \times \left(\frac{3}{4} + \left(\frac{3}{4} \right)^2 + \left(\frac{3}{4} \right)^3 + \dots \right) \right].$$

Now we need the formula for the sum of a geometric progression

$$\frac{3}{4} + \left(\frac{3}{4} \right)^2 + \left(\frac{3}{4} \right)^3 + \dots = \frac{3/4}{1-3/4} = 3.$$

Putting in the values (a calculator is not needed!) the time T required for what in theory is an infinite number of bounces comes out as 5 seconds exactly.

8.7 Oblique impacts

Example 8.11

A snooker cue ball, travelling at speed 0.5 m/s, makes an oblique impact with a stationary object (target) ball of equal mass m . After impact, the cue ball is deflected through an angle of 30° while the object ball moves away at an angle of 60° from the original line of the cue ball. Find (a) the speeds v and w of the balls after impact and (b) the coefficient of restitution.

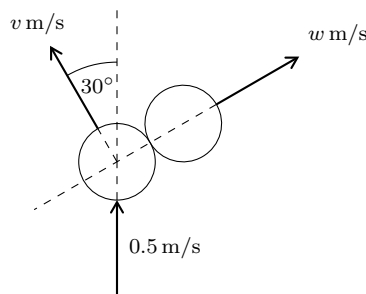

After the impact, the components of velocity along the original line of motion of the cue ball are $v \cos(30^\circ) = \sqrt{3}v/2$ for the cue ball and $w \cos(60^\circ) = w/2$ for the object ball. Conservation of momentum along this line gives

$$0.5m = \frac{\sqrt{3}mv}{2} + \frac{mw}{2}.$$

But momentum is also conserved in the transverse direction. If the object ball goes to the right, the cue ball must deviate to the left. After impact, the momentum of the cue ball to the left is $mv \sin(30^\circ) = mv/2$, and this must balance the momentum of the object ball to the right, $mw \sin(60^\circ) = \sqrt{3}mw/2$:

$$\frac{mv}{2} = \frac{\sqrt{3}mw}{2}.$$

Solving simultaneously, we find $v = \sqrt{3}/4 = 0.43 \text{ m/s}$, $w = 1/4 = 0.25 \text{ m/s}$.

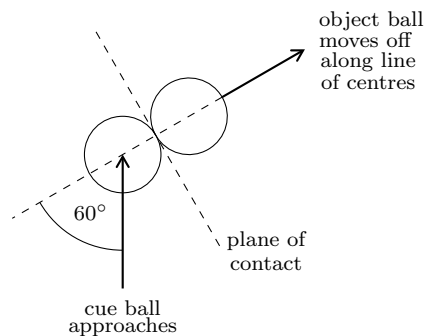

At the moment of contact, the two balls touch on their common tangent plane and the cue ball exerts an impulse on the object ball perpendicular to this plane, along the line joining their centres. For the coefficient of restitution, we calculate approach speed and separation speed using velocity components in this same direction. Here, the cue ball travels towards the object ball with speed 0.5 m/s at an angle of 60° to the line of centres, giving an approach speed of $0.5 \cos(60^\circ) = 0.25 \text{ m/s}$. After impact, the cue ball is moving perpendicular to the line of centres so that the separation speed is simply the speed of the object ball, $w = 0.25 \text{ m/s}$. So

$$e = \frac{\text{separation speed}}{\text{approach speed}} = \frac{0.25}{0.25} = 1.$$

The collision is therefore perfectly elastic. This example illustrates a general rule, applicable to ideal, perfectly elastic snooker ball collisions, that after impact the cue ball and object ball move off at right angles to each other. A more general calculation shows that the 90° angle is a maximum value – if the coefficient of restitution is less than unity, the angle between the two velocities is always less than 90° .

Example 8.12

A tennis ball travelling at an angle of 30° to the horizontal bounces off a smooth level surface. The coefficient of restitution is $e = 0.75$. At what angle θ will the ball rebound?

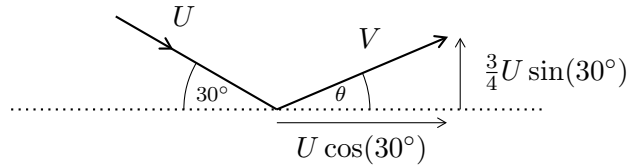

If the surface is smooth and so without friction, there are no horizontal forces acting on the ball, even during impact. Its horizontal momentum and horizontal velocity component remain unchanged. If the speed just before impact is U , and just after impact is V , $V \cos \theta = U \cos(30^\circ)$.

Considering the vertical motion, the approach speed and separation speed for the impact are defined in relation to the plane of contact, in this case the ground surface itself. The approach speed is the downward component of the incoming speed U , $U \sin(30^\circ)$. The separation speed is the upward component of the outgoing speed V , $V \sin \theta$. By Newton's law of restitution, $V \sin \theta = e \times U \sin(30^\circ) = 0.75 \times U \sin(30^\circ)$. From the velocity triangle, $\tan \theta = 0.75 \tan(30^\circ)$, and we find $\theta = 23^\circ$, independently of the initial speed U .

Please click the advert

YOUR CHANCE TO CHANGE THE WORLD

ericsson.com

Here at Ericsson we have a deep rooted belief that the innovations we make on a daily basis can have a profound effect on making the world a better place for people, business and society. Join us.

In Germany we are especially looking for graduates as Integration Engineers for

- Radio Access and IP Networks
- IMS and IPTV

We are looking forward to getting your application! To apply and for all current job openings please visit our web page: www.ericsson.com/careers



Download free ebooks at bookboon.com

9 Energy

9.1 Potential energy and kinetic energy

Imagine, said Galileo, that this page represents a vertical wall, with a nail driven into it at A, and from the nail let there be suspended a lead bullet by means of a fine vertical thread AB, say four to six feet long. On the wall let us draw a horizontal line CD at right angles to the vertical thread AB, which hangs about two finger breadths in front of the wall.

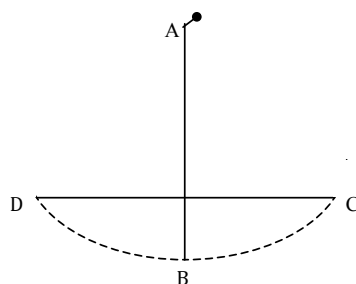

Then, if the thread is drawn aside till the bullet is in position C, and then released, it will descend along the arc CB, passing B, and rise again until it almost reaches the horizontal CD, any slight shortfall being caused by the resistance of the air or of the fixing of the string at A.

Again, suppose another nail is driven into the wall close to the vertical AB, say at E, but protruding about five or six finger breadths so that the thread catches on it when released from C. Now the bullet, having reached B, will continue upwards on an arc BF, centred at E, and again will reach or very nearly reach the horizontal CD.

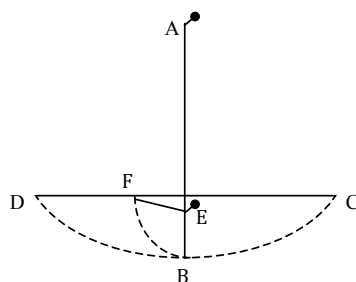

Depending on the position of the nail E, the final position F will vary, but – so long as E is not so far below CD that the string winds itself round and round the nail – F will always lie on the horizontal CD. In modern terminology, we would say that this constancy reflects the fact that all positions along the horizontal CD have the same gravitational potential energy, relative to the low point at B. The term potential energy conveys the idea of a store of energy, not actually visible but available for use, as when the bullet is held to one side at C, but is not yet released, or when it rises again to D before swinging

back again. The formula for the potential energy of a particle of mass m at a height h above a chosen baseline level, is

$$\text{Potential energy} = mgh , \quad (9.1)$$

where g is the acceleration due to gravity.

By contrast, kinetic energy is energy which shows directly in the motion of a particle, as when the bullet traverses the arcs CBD or CBF. The kinetic energy of a particle of mass m , travelling at speed v , is given by the formula

$$\text{Kinetic energy} = \frac{1}{2}mv^2 . \quad (9.2)$$

Both potential energy and kinetic energy are measured in units of joules, abbreviated as J.

9.2 Conservation of mechanical energy

Galileo's example shows how the potential energy before the motion starts is the same as the potential energy after it is complete. The principle of the conservation of energy goes further to say that the total energy remains constant throughout. The same quantity of energy, existing first as potential energy, is transformed into kinetic energy before returning once again to potential energy.

Strictly, we are speaking here of the conservation of mechanical energy, which applies, as Galileo noted, only when dissipative forces such as friction or air resistance can be ignored. Often, energy will appear to be lost. Even so, like the horizontal line CD in Galileo's illustration, the conservation principle sets a limit to the possible range of motion.

Example 9.1

A stone of mass m falls from rest through a distance h , hitting the ground with speed v . Show how the principle of the conservation of mechanical energy applies in this case.

To find the speed v at impact, apply the constant acceleration formula, $v^2 = u^2 + 2as$, with $u = 0$, since the stone falls from rest, $s = h$, and $a = g$, the acceleration due to gravity. Then

$$v^2 = 0 + 2gh ,$$

or multiplying both sides by $\frac{1}{2}m$,

$$\frac{1}{2}mv^2 = mgh .$$

The kinetic energy gained during the descent, if air resistance is neglected, is equal to the potential energy lost, so that the total mechanical energy remains the same.

Example 9.2

Starting from rest, a mass m slides down a smooth slope through a vertical distance h . Show again that in the absence of friction the total mechanical energy is conserved.

Suppose first that the slope has a uniform gradient inclined at an angle α to the horizontal. Then the acceleration down the slope will be $g \sin \alpha$ and the slant distance travelled to the bottom will be $h/\sin \alpha$. To find the speed v at the bottom of the slope, apply the constant acceleration formula, $v^2 = u^2 + 2as$, with $u = 0$, $s = h/\sin \alpha$, and $a = g \sin \alpha$. Then

$$v^2 = 0 + 2g \sin \alpha \frac{h}{\sin \alpha} .$$

The factors of $\sin \alpha$ cancel and the final kinetic energy $\frac{1}{2}mv^2$ is, as in *Example 9.1*, equal to the initial potential energy mgh .

Notice that this conclusion is independent of the angle α . It applies therefore, to a slope of any angle, or to a slope comprising two sections with different angles, but still falling through a total vertical distance h , or indeed to any slope, following any profile, whether curved or linear.

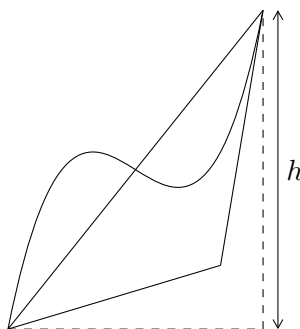

Figure 9.1: *Alternative descents with the same final velocity.*

Example 9.3

Usually, mechanical energy is lost during a collision. When a drop of water splashes on a hard surface, energy is lost to the viscous and surface tension forces in the drop, and when car A hits bus B, energy is consumed in deforming the bodywork.

Elastic collisions are a special case. These are collisions in which the coefficient of restitution e is equal to unity. A ball bouncing on a hard surface with $e = 1$ would rebound with its original speed and kinetic energy, and rise again to the height from which it was dropped.

In *Chapter 8* we looked at the example of an oblique collision between ideal perfectly elastic snooker balls, with speeds before and after impact as shown in *Figure 9.2*.

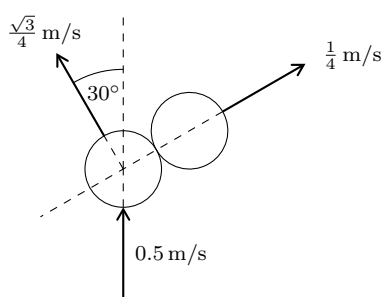

Figure 9.2: *The oblique collision of Example 8.11.*

Before impact, the kinetic energy of the cue ball was $\frac{1}{2}m(0.5)^2 = 0.125m$ J, if the mass m of the balls is measured in kg. After impact, the combined kinetic energy adds to

$$\frac{1}{2}m \left(\frac{\sqrt{3}}{4}\right)^2 + \frac{1}{2}m \left(\frac{1}{4}\right)^2 = 0.125m \text{ J} ,$$

so that here also energy is conserved.

9.3 The work-energy principle

Usually, the system we have to study interacts with its environment. Energy losses, arising from friction or air resistance, or energy inputs, as from the engine of a car, will also need to be accounted for. The examples we have considered so far, where an independent energy balance is maintained, are approximate models or special cases.

The contribution of a force to the energy budget of a system is expressed by the concept of ‘work’. The work done by a force F moving through a distance d is defined as the product $F \times d$. This is an intuitively reasonable definition. A greater force and a greater distance both imply greater expenditure of effort. If we carry a mass of 10 kg up a flight

of stairs which rises through a vertical distance of 3 metres, the force which has to be applied is equal to the weight $10g = 98$ newtons, and the work done is $98 \times 3 = 294$ J, equal to the increase in potential energy of the mass.

Notice here that the horizontal distance travelled while going up the stairs does not enter into the calculation of the work done. It is a vertical force F which is required to lift the weight, and the distance d is measured in the same direction.

In the case of an energy loss, as opposed to an energy input, the applied force F is in the opposite direction to the distance d . The air resistance force on a car, for example, is in the opposite direction to the motion of the car.

Example 9.4

Estimate the force applied to a cricket ball when it is thrown a distance of 50 metres.

If the throw covers the 50 m distance as a full toss, its initial velocity energy can be estimated from the formula V^2/g for the horizontal range of a projectile: $V^2 = 50g = 490$ m/s. With a mass of 160 grams, the kinetic energy comes out as $\frac{1}{2} \times 0.16 \times 490 = 39.2$ J. (Notice we need not waste effort with a square root operation to find V , when it is V^2 which we really want in order to find the kinetic energy). If the propulsive force F is applied over a distance of one metre, while the ball is in the throwers hand, $F \times 1 = 39.2$, and the applied force must be about 40 newtons.

Please click the advert

I joined MITAS because
I wanted **real responsibility**

The Graduate Programme
for Engineers and Geoscientists
[Maersk.com/Mitas](https://www.maersk.com/mitas)



Month 16

I was a construction
supervisor in
the North Sea
advising and
helping foremen
solve problems

Real work
International opportunities
Three work placements





Download free ebooks at bookboon.com

Example 9.5

A dart of mass 25 grams is thrown at a dartboard with speed 10 m/s. On impact, the spike penetrates a distance 1 cm into the board. Estimate the resistance force experienced by the dart.

Suppose that the resistance force is constant and equal to R newtons. The work done by R against the dart is $R \times 0.01$ J which must be equal to its loss of kinetic energy, which is $\frac{1}{2} \times 0.025 \times 10^2$ J. Hence $R = 125$ newtons.

9.4 Power

Power is the rate of doing work. The power output P of an engine which delivers W joules of work in a time t is

$$P = \frac{W}{t} . \quad (9.3)$$

There is also an alternative formula which may be found by remembering that the work done W is equal to $F \times d$. Then

$$\begin{aligned} P &= \frac{W}{t} \\ &= \frac{F \times d}{t} \\ &= F \times \frac{d}{t} \\ &= F \times v , \end{aligned} \quad (9.4)$$

since speed v equals distance divided by time.

Power is measured in units of watts. The units of power and energy, the watt and the joule, are named respectively after James Watt (1736 – 1819), the inventor of the steam engine, and James Joule (1818 – 1889). Joule demonstrated the equivalence of mechanical energy and heat in an experiment in which the potential energy of a falling weight was transformed into the kinetic energy of a set of paddles in a water tank and finally into the heat energy of the water. The story goes that later, while on honeymoon, he sought to confirm this result by measuring the temperature difference between the water at the top and bottom of a high waterfall in the Alps.

Example 9.6

A sparrow generating a power output of 1 watt flies at a speed of 10 m/s. What is the propulsive force which it is exerting?

With a power output of 1 watt, the propulsive force exerted by the sparrow must be $F = P/v = 0.1$ newtons.

Example 9.7

A cyclist in the Tour de France climbs steadily up a gradient of 1 in 10. If the combined mass of the cyclist and his cycle is 70 kg, and his power output is 300 watts, calculate his speed.

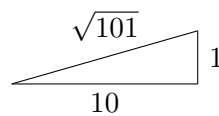

Suppose the speed of the cyclist is V . In each second, the distance travelled up the slope is V metres, corresponding (by Pythagoras' theorem) to a gain in height of $V/\sqrt{101}$ metres. The resulting gain in potential energy may be equated to the work done by the cyclist in the same one second interval. Thus

$$\begin{aligned} 300 \times 1 &= 70 \times 9.8 \times \frac{V}{\sqrt{101}} \\ \Rightarrow V &= 4.4 \text{ m/s} . \end{aligned}$$

At this relatively low speed, it is a reasonably good approximation to omit the effects of air resistance.

Example 9.8

Mr A in his limousine, total mass 2000 kg, is cruising at a steady speed of 20 m/s. The power output from the engine is 5 kW. He now puts his foot on the accelerator, increasing the power to 15 kW. What is the acceleration of the car?

At a power output of 5 kW, the tractive force exerted by the engine is $P/v = 5000/20 = 250$ newtons, and since the speed is constant, the resistance forces must also be of the same magnitude 250 newtons.

When Mr A puts his foot on the accelerator, the tractive force from the engine increases to $15000/20 = 750$ newtons, and, allowing for the resistance forces, the resultant forward force on the car is $750 - 250 = 500$ newtons. By Newton's second law, therefore, the acceleration of the car is 0.25 m/s^2 .

Example 9.9

The maximum power output of Mr A's engine is 100 kW. If the total resistance force when travelling at speed V is $0.625V^2$, what is the maximum speed achievable on a level road.

At maximum speed, the tractive force from the engine must match the resistance force.

$$\frac{P}{V} = 10^5 V = 0.625V^2 .$$

So $V^3 = 160,000$ and $V = 54$ m/s, or 194 km/hr.

Please click the advert

Brain power

By 2020, wind could provide one-tenth of our planet's electricity needs. Already today, SKF's innovative know-how is crucial to running a large proportion of the world's wind turbines.

Up to 25 % of the generating costs relate to maintenance. These can be reduced dramatically thanks to our systems for on-line condition monitoring and automatic lubrication. We help make it more economical to create cleaner, cheaper energy out of thin air.

By sharing our experience, expertise, and creativity, industries can boost performance beyond expectations. Therefore we need the best employees who can meet this challenge!

The Power of Knowledge Engineering

Plug into The Power of Knowledge Engineering.
Visit us at www.skf.com/knowledge

SKF

Download free ebooks at bookboon.com

10 Circular motion

10.1 Centripetal acceleration

Consider a particle moving in a circle at constant speed. It is not in equilibrium, for this implies a state of rest, or motion in a straight line. But, if the speed is constant, in what sense is there an acceleration?

To resolve the paradox, we have to remember that acceleration is the rate of change of velocity and that velocity is a vector quantity, possessing both magnitude and direction. And though the speed remains constant, the direction is continuously changing, turning inwards away from the straight line direction along the tangent.

Because there is a change in direction towards the centre of the circle, there is what is called a centripetal acceleration, or literally a centre-seeking acceleration.

To calculate the acceleration, Newton visualised the particle moving at speed v on a many-sided path ABC... within a circular wall, radius r , undergoing a series of glancing impacts.

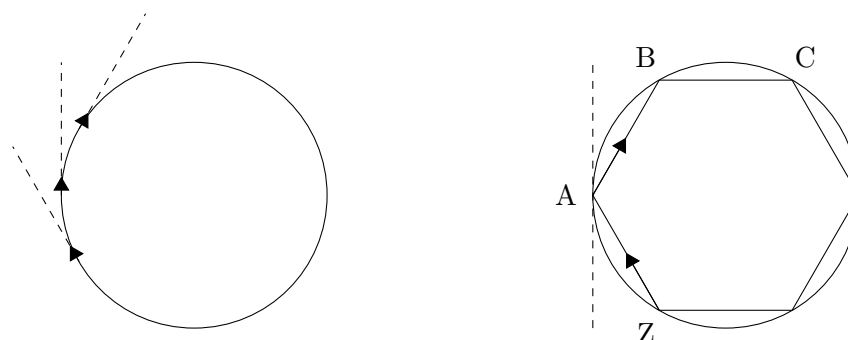

Figure 10.1: *Motion in a circle showing the changing direction of the velocity (left) and Newton's many-sided path visualisation of the problem (right).*

For example, at A, the component of velocity along the tangent is unchanged, but the particle receives an impulse to the right, towards the centre of the circle. As the particle moves round the path ABC...ZA, receiving successive impacts, its velocity vector rotates. To show this, we can draw a vector diagram with the velocities in the segments AB, BC, shown as arrows of constant length v with their tails anchored at a common origin.

The changes in velocity at A, B, ... resulting from the impulses at A, B, ... can now be represented by vectors Δv_A , Δv_B , ... as shown in *Figure 10.2*.

When the path ABC...ZA has a large number of sides N , its total length is very close to the circumference $2\pi r$ of the surrounding circle. The time taken for a complete circuit,

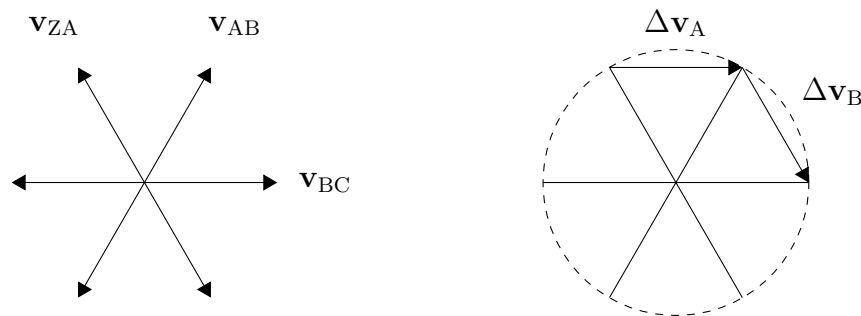

Figure 10.2: The diagram on the left shows the velocity vectors anchored at a common origin, while that on the right shows the changes in velocity at A, B, ...

travelling at speed v , is $2\pi r/v$, and the time taken to traverse each side is $\Delta t = 2\pi r/Nv$. Likewise the changes Δv at successive vertices A, B, ... are approximated by arcs of the circumference of a circle, radius v , in the velocity diagram, and these are each of magnitude $2\pi v/N$. The magnitude of the acceleration, therefore, is

$$\begin{aligned}
 a &= \frac{\Delta v}{\Delta t} \\
 &= \frac{2\pi v/N}{2\pi r/Nv} \\
 &= \frac{v^2}{r}, \qquad (10.1)
 \end{aligned}$$

and its direction is always towards the centre of the circle.

10.2 Motion in a horizontal circle

The implication of the centripetal acceleration formula is that when a body moves in a circle, it is because some force constrains it to do so. We see this in the tension in the string when a boy whirls a conker above his head, or the tension in the wire when a hammer thrower prepares to throw in an athletics competition.

Example 10.1

A car negotiates a bend in the road with a radius of curvature of 50 metres. If the road is level, and the coefficient of friction between the tyres and the road is $\mu = 0.8$, what is the maximum safe speed?

Suppose the car has mass M and the maximum safe speed is V . What holds the car to the curve of the road, or, more exactly, keeps the car accelerating inwards towards the centre point of the curve, is the frictional force from the surface. The maximum speed is reached when the frictional force F_f attains its limiting value μMg . By Newton's second

law, therefore

$$F = Ma$$

$$\begin{aligned}\Rightarrow F_f = \mu Mg &= "mv^2/r" \\ &= MV^2/50 ,\end{aligned}$$

giving $V = \sqrt{50 \times 0.8 \times 9.8} = \sqrt{392} = 19.8$ m/s. The occupants of the car, especially any passengers on the rear seat, will perhaps find themselves sliding towards the outside of the bend, a phenomenon which is often ascribed to ‘centrifugal force’. This is a somewhat misleading term, however, in that there is no real force impelling them outwards, but only the natural tendency of their bodies to persist in the original line of motion of the car. “Centrifugal force” is an illusion, originating with the unfounded assumption that our bodies will follow round the corner purely in obedience to the intentions of the driver. A similar situation operates in straight line motion when the driver brakes suddenly. Then, the occupants in the car, continuing with their previous motion, appear to be thrown forward, relative to the car.

Please click the advert

Are you considering a European business degree?

LEARN BUSINESS at university level. We mix cases with cutting edge research working individually or in teams and everyone speaks English. Bring back valuable knowledge and experience to boost your career.

MEET a culture of new foods, music and traditions and a new way of studying business in a safe, clean environment – in the middle of Copenhagen, Denmark.

ENGAGE in extra-curricular activities such as case competitions, sports, etc. – make new friends among CBS’ 18,000 students from more than 80 countries.





See what we look like and how we work on cbs.dk



Download free ebooks at bookboon.com

Example 10.2

Mr C, mass 60 kg, turns a corner on his bicycle, mass 5 kg, in an arc of radius 20 m. If he is travelling at 5 m/s, what is the angle at which he will need to ‘lean in’ to the curve?

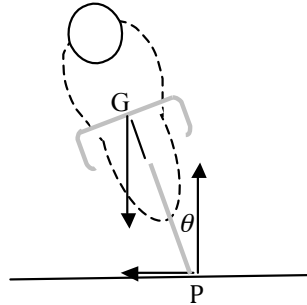

The principle here is essentially the same as in *Example 10.1*, but Mr C needs to be considered as a rigid body. A simple particle cannot ‘lean’ one way or the other. There are three forces acting which need to be taken into account. The weight of Mr C and his cycle, $Mg = 65 \times 9.8 = 637$ newtons, acts downwards through their combined centre of gravity. The upward reaction from the ground N , also 637 newtons in magnitude, acts upwards through P, the point of contact of the tyres with the ground. The third force is the frictional force F_f , acting horizontally through the point of contact with the ground.

The frictional force F_f keeps Mr C accelerating towards the centre of his curved path. From Newton’s second law

$$\begin{aligned} F_f &= \frac{Mv^2}{r} \\ &= 65 \times \frac{5^2}{20} \\ &= 81.25 \text{ newtons .} \end{aligned}$$

If Mr C is to remain stable, the turning moments of the forces about the centre of gravity G must cancel.

$$F_f \times GP \cos \theta = N \times GP \sin \theta ,$$

so that

$$\begin{aligned} \tan \theta &= \frac{\sin \theta}{\cos \theta} \\ &= \frac{F_f \times GP}{N \times GP} \\ &= \frac{F_f}{N} \\ &= \frac{81.25}{637} \\ &= 0.128 , \end{aligned}$$

and $\theta = 7^\circ$. Notice that the distance GP cancels out from the final answer, as also would the mass M , if we had left it in algebraic form.

Example 10.3

In a conical pendulum the bob goes round and round in a circle rather than to-and-fro. It is called a ‘conical’ pendulum because the motion of the string, following the bob, traces out the surface of a cone. Just like a standard pendulum, it provides a measure of time. Suppose that one end of the string is fixed to a point O while the other end is attached to the bob B which moves in a horizontal circle with its centre a distance h below O. What is the time taken for B to complete one circuit?

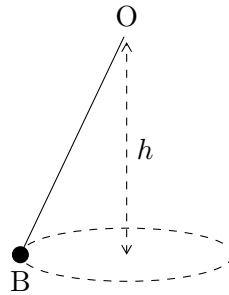

Eventually, as we will see, the formula for the period of the motion t will only involve the variable h and the acceleration due to gravity g . But we need to label a few more quantities to develop the intermediate working. Suppose that the mass of the bob is m , the tension in the string is T , and the inclination of the string to the vertical is θ . Then the bob moves in a circle of radius $R = h \tan \theta$ with speed $V = 2\pi R/t$.

Resolving forces vertically gives

$$T \cos \theta = mg .$$

Resolving horizontally, and taking account of the centripetal acceleration

$$\begin{aligned} T \sin \theta &= \frac{mV^2}{R} \\ &= \frac{(2\pi R/t)^2}{R} . \end{aligned}$$

Dividing the second equation by the first,

$$\tan \theta = \left(\frac{2\pi}{t} \right)^2 \frac{R}{g} ,$$

and remembering $R = h \tan \theta$,

$$t = 2\pi \sqrt{\frac{h}{g}} . \quad (10.2)$$

With a distance h of 1 metre, therefore, the period of the motion is almost exactly 2 seconds.

10.3 Motion in a vertical circle

Similar principles apply to the analysis of motion in a vertical circle. The main difference is that because there will be differences in gravitational potential energy at different positions on the circle, there will be differences in kinetic energy and the speed will therefore vary.

Example 10.4

A car drives over a hump-backed bridge. The profile of the humped surface is taken as circular with a radius of curvature of 40 metres. At what speed can the car be driven over the bridge without losing contact with the road?

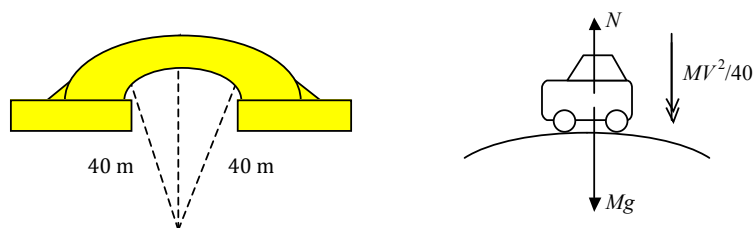

Figure 10.3: A bridge with radius of curvature of 40 m (left) and the resultant forces and accelerations on the car (right).

Please click the advert



The financial industry needs a strong software platform

That's why we need you

SimCorp is a leading provider of software solutions for the financial industry. We work together to reach a common goal: to help our clients succeed by providing a strong, scalable IT platform that enables growth, while mitigating risk and reducing cost. At SimCorp, we value commitment and enable you to make the most of your ambitions and potential.

Are you among the best qualified in finance, economics, IT or mathematics?

Find your next challenge at
www.simcorp.com/careers



www.simcorp.com

MITIGATE RISK | REDUCE COST | ENABLE GROWTH

Suppose the car has mass M and is travelling at speed V . On a level road, the normal reaction from the road surface on to the car is equal to its weight Mg , but on top of the bridge it takes a lower value N . The difference $Mg - N$ constitutes a net downward force which ensures the car follows the profile of the road, accelerating downwards towards the centre of curvature. So

$$Mg - N = \frac{MV^2}{40}.$$

In the limiting case, when the car is on the point of becoming airborne, N reduces to zero, since clearly N must be zero once it is no longer in contact with the road. The critical value of V therefore satisfies the equation

$$Mg = \frac{MV^2}{40},$$

so that

$$\begin{aligned} V &= \sqrt{40g} \\ &= 19.8 \text{ m/s}. \end{aligned}$$

In fact, the car would be difficult to handle even at lower speeds. The reduced normal reaction would lead to a lower limiting frictional force and – as in *Example 10.1* – a lesser capability of negotiating any bend.

Example 10.5

A child of mass 30 kg on a playground swing moves through an arc extending for 30° either side of the vertical. The chains holding the swing are 2 metres long. What is the tension in the chains at **(a)** the extreme points of the motion and **(b)** at the lowest point?

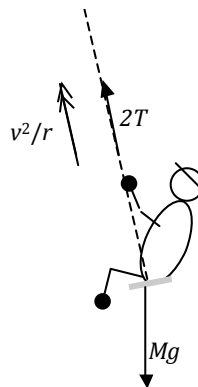

At the extreme points of the arc, the speed is instantaneously zero, and the acceleration radially, towards the centre of the child's circular arc, is shown by the v^2/r formula to be zero. Resolving forces in the radial direction, therefore

$$2T = 30g \cos(30^\circ),$$

assuming that the swing is supported by two chains and that the tension in each is T . We have also ignored the mass of the swing itself. With these assumptions, we find $T = 127$ newtons.

At the lowest point of the motion the speed is greatest. If the effects of air resistance and the friction in the fastenings of the chain can be ignored, energy is conserved. The gravitational potential energy at the high point of the motion is transformed into kinetic energy at the low point. Then

$$Mgh = 30g(2 - 2\cos(30^\circ)) = \frac{1}{2}Mv^2 ,$$

so that $v^2 = 5.25 \text{ m}^2/\text{s}^2$, $v = 2.29 \text{ m/s}$.

Resolving forces radially again, therefore, at the low point

$$\begin{aligned} 2T - Mg &= M\frac{v^2}{r} \\ \Rightarrow T &= 30 \times \frac{9.8 + 5.25/2}{2} \\ &= 186 \text{ newtons} . \end{aligned} \tag{10.3}$$

We are here treating the child as a ‘particle’. Strictly, the centre of gravity will be slightly above the seat of the swing, and will move in a circle of radius slightly less than the 2 metre value assumed. This will lead to a slighter larger value of T than the one we have calculated.

10.4 The pendulum

The period of oscillation of a simple pendulum is independent of the amplitude of the swing, so long as this is small compared with the length of the string. This was discovered by Galileo while a student at Pisa, taking his inspiration from his observation of the motion of a suspended lamp during Mass in the cathedral.

To investigate the motion of the pendulum, we look at the balance of kinetic and potential energy as it moves in a circular arc from E to F around a centre point C.

Because of the geometry of the circle, there is a relationship between the distance CE and the vertical height gained $CM = H$. The angle CET is a right angle (“angle in a semi-circle”) and so the triangles TEC and EMC are similar. From their ratios

$$\frac{CE}{CT} = \frac{CM}{CE} .$$

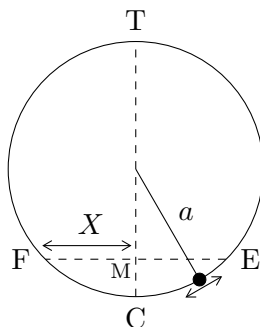

If the pendulum swings only through a small angle, its maximum horizontal displacement $ME = MF = X$ is approximately the same as the distance CE , so

$$H = CM = \frac{CE^2}{CT} = \frac{X^2}{2a} ,$$

where a is the length of the pendulum string. With this formula, we can use the size of the swing to measure the gain in height.

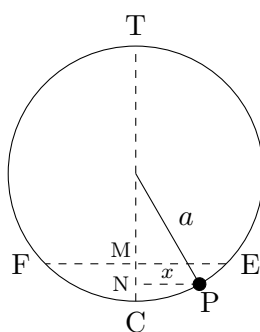

Similarly, the height CN gained at an intermediate point P is determined by the horizontal displacement $NP = x$

$$h = CN = \frac{CP^2}{CT} = \frac{x^2}{2a} .$$

Considering the conservation of energy, the total energy at P must be the same as the total energy at E , which is purely potential energy. If the speed at P is v

$$mgH = \frac{1}{2}mv^2 + mgh ,$$

Cancelling the factor m , and using the formulæ for the heights h and H

$$\frac{g}{2a}X^2 = \frac{1}{2}v^2 + \frac{g}{2a}x^2 ,$$

gives the speed of the bob v in terms of its position x on the swing

$$v = \sqrt{\frac{g}{a}(X^2 - x^2)} = V_{\max} \sqrt{\left(1 - \frac{x^2}{X^2}\right)} .$$

What does this formula tell us? The special case of the central position $x = 0$ is informative. Here the speed takes its maximum value $v = V_{\max} = X\sqrt{g/a}$ and we see that it is proportional to the amplitude of the swing X . If we halve the amplitude, we halve the speed. This indeed suggests that the time required per oscillation remains constant even when the amplitude changes. But the proof is not complete, because the speed varies from point to point on the swing. To complete the demonstration we use the idea of what is called the auxiliary circle.

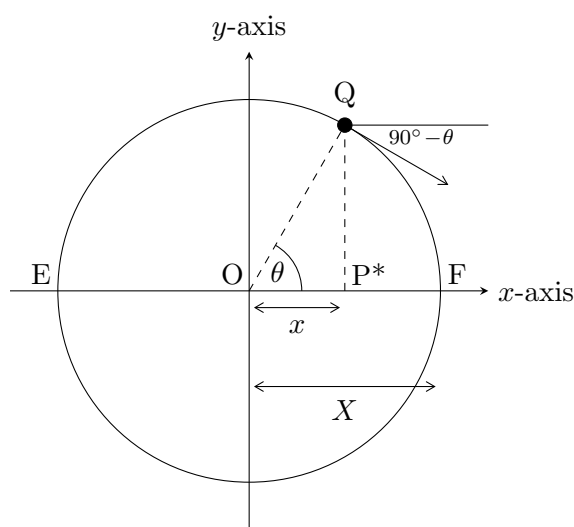

Figure 10.4: *The auxiliary circle.*

Please click the advert

What do you want to do?

No matter what you want out of your future career, an employer with a broad range of operations in a load of countries will always be the ticket. Working within the Volvo Group means more than 100,000 friends and colleagues in more than 185 countries all over the world. We offer graduates great career opportunities - check out the Career section at our web site www.volvogroup.com. We look forward to getting to know you!

VOLVO

AB Volvo (publ)
www.volvogroup.com

VOLVO TRUCKS | RENAULT TRUCKS | MACK TRUCKS | VOLVO BUSES | VOLVO CONSTRUCTION EQUIPMENT | VOLVO PENTA | VOLVO AERO | VOLVO IT
VOLVO FINANCIAL SERVICES | VOLVO 3P | VOLVO POWERTRAIN | VOLVO PARTS | VOLVO TECHNOLOGY | VOLVO LOGISTICS | BUSINESS AREA ASIA

Download free ebooks at bookboon.com

Imagine a point Q moving in a circle in the x - y plane. We choose the radius of the circle as X , the same as the amplitude of our pendulum oscillations, and suppose that Q moves at a constant speed $V = X\sqrt{g/a}$ equal to the maximum speed of the pendulum bob.

As Q moves round the circle, P^* , the foot of the perpendicular from Q to the x -axis, moves backwards and forwards between the endpoints E and F. P^* is a kind of artificial bob which mimics the motion of the real pendulum bob. We see that it has the same amplitude of motion, $\pm X$ about its centre point at the origin, and the same maximum speed V , attained when P^* is at the origin and Q crosses the y -axis.

It remains to verify that P^* has the correct speed at intermediate points. From the diagram, at a distance x from the origin, the speed of P is equal to the x -component of the speed of Q, that is $v = V \cos(90^\circ - \theta) = V \sin \theta = V \times (QP^*/OQ) = V \sqrt{(X^2 - x^2)}/X$. Remembering $V = X\sqrt{g/a}$, we have finally

$$v = \sqrt{\left[\frac{g}{a}(X^2 - x^2)\right]}$$

which is the same speed-distance formula as for the real pendulum bob P.

The period of oscillation is the time required for one complete cycle of the pendulum's motion – starting at the centre C, moving to the extreme point E, then in the reverse direction to F, and finally back again to C. During this time the auxiliary bob completes one circuit of the auxiliary circle, covering the circumferential distance $2\pi X$ at a speed $V_{\max} = X\sqrt{g/a}$. The period of oscillation, therefore, is

$$t = 2\pi X \div X\sqrt{\frac{g}{a}} = 2\pi\sqrt{\frac{a}{g}}, \quad (10.4)$$

independently of the amplitude X .

Example 10.6

A pendulum of length one metre swings through an angle of 5° either side of its resting position C to extreme points E and F. Calculate the time taken from C to reach **(a)** maximum amplitude at E and **(b)** half amplitude at H, where H is the mid-point of CE and **(c)** to arrive at H for the third time.

For a pendulum of length 1 metre, the period of small oscillations will be $T = 2\pi\sqrt{1/9.8} = 2.007$ s, irrespective of their exact magnitude.

On the auxiliary circle, C_1 corresponds to C on the pendulum arc. Likewise C_2 and C_3 correspond to H and E (see *Figure 10.5*).

Travelling from C to E with the pendulum corresponds to the quarter circle $C_1C_2C_3$ on the auxiliary circle, so the time needed is $T/4 = 0.50$ seconds.

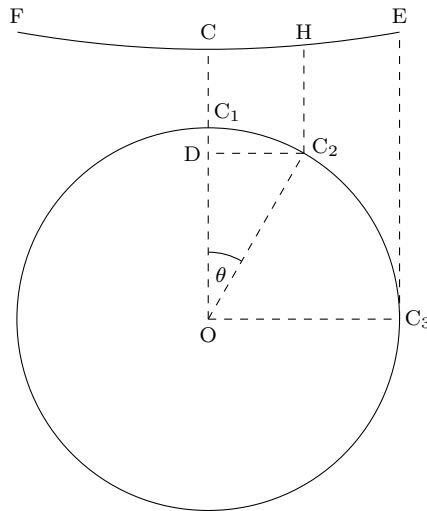

Figure 10.5: *The auxiliary circle for Example 10.6.*

Travelling from C to H corresponds to an arc of angle θ on the auxiliary circle, where θ is the angle DOC_2 . From the geometry, $\sin \theta = DC_2/OC_2 = CH/OC_3 = \frac{1}{2}CE/CE = 1/2$, and $\theta = 30^\circ$. The arc is therefore one twelfth of the complete circle and the time for the pendulum to reach H from C is $T/12 = 0.17$ s.

The pendulum passes through H twice in one complete oscillation, once on the way out to E and once on the way back. After one oscillation it reaches H for the third time after a time interval $T + T/12 = 2.17$ s.

RedStarResume.

Do you want your Dream Job?

More customers get their dream job by using RedStarResume than any other resume service.

RedStarResume can help you with your job application and CV.

Go to: Redstarresume.com

Use code "BOOKBOON" and save up to \$15

(enter the discount code in the "Discount Code Box")

Please click the advert

11 Gravitation and planetary motion

11.1 The Copernican model

Anyone who looks at the night sky for an hour or two will see that the stars and constellations move as a single unit, wheeling around the Pole Star. The convincing appearance is that the observer is at rest on a fixed Earth while the heavens revolve, and this was the picture of the universe accepted without question all through the Middle Ages. The sphere of the fixed stars was the outer limit of the universe while the earth was fixed at the centre. Between the two, the Sun, Moon and planets moved in their own orbits against the background of the stars.

The planetary orbits were taken as circular, or to fit more closely with observations, made from epicycles, circles moving upon circles. It was thought that the mathematical perfection of the circle could best reflect the divine intelligence of the celestial world, contrasting with the imperfections of worldly – literally mundane – life on earth. Practically, it makes no difference to the observations, whether the Sun and planets revolve around the Earth, or the planets, including the Earth, around the Sun. But it would have been a bold man who proposed the Sun-centred system as an actual reality, for this would mix the two worlds together, the celestial and the mundane. Most probably it was for this reason that Copernicus waited almost until he was on his death-bed before publishing his heliocentric model *On the revolutions of the heavenly spheres* in 1543.

Even with his new model Copernicus remained convinced that the revolutions of the planets were based on circles. It was the young mathematician Johannes Kepler, working in the 1590s with more accurate data, who found that the orbit of Mars just would not fit without an unreasonably large number of secondary circles. Driven on by the conviction that the true picture must somehow show a divine simplicity, he was led to three laws of planetary motion.

11.2 Kepler's first law

Kepler's first law says that the planets revolve in ellipses with the Sun at one focus.

To draw an ellipse, imagine two nails, fixed six inches or a foot apart, and a string two or three feet long tied to the nails at each end. Now hold a pen P against the string so that it is stretched taut. As P moves within the constraining string, it traces out an ellipse.

The ellipse has two foci, F_1 and F_2 , at the positions of the two nails, while its geometric centre lies at O mid-way between them.

For most of the planets, including the Earth, the orbit does not differ greatly from a circle.

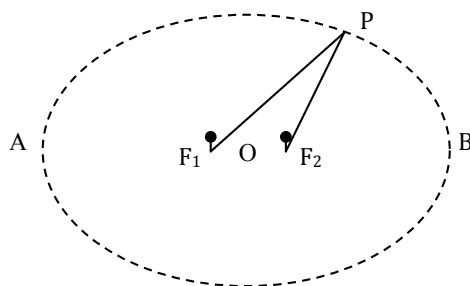

Figure 11.1: An ellipse with foci at F_1 and F_2 and centre at O .

F_1 and F_2 are relatively close together, and the eccentricity (ε) of the ellipse – the ratio of the distance OF_1 to OA – is small. *Table 11.4* shows the dimensions and eccentricity for the orbits of the major planets, distances being given in astronomical units (a.u.), where 1 a.u. is the mean distance of the Earth from the Sun, 149.6 million kilometres.

Planet	Mean radius (a.u.)	Eccentricity (ε)	Period (years)
Mercury	0.387	0.206	0.241
Venus	0.723	0.007	0.615
Earth	1	0.0167	1
Mars	1.524	0.093	1.88
Jupiter	5.204	0.049	11.9
Saturn	9.582	0.057	29.4
Uranus	19.201	0.047	83.7
Neptune	30.047	0.011	163.7
Pluto	39.236	0.244	248

Table 11.4: *Parameters for planetary orbits.*

Example 11.1

Find the greatest and least distances of the Earth from the Sun.

In the ellipse diagram, if the Sun is at the focus F_1 , AF_1 represents the closest approach of the Earth to the Sun (perihelion), BF_1 is the furthest separation (aphelion), and the mean distance is $OA = OB = 149.6$ million km. If $OF_1/OA = \epsilon = 0.0167$, $AF_1 = (1 - \epsilon)OA = 147.1$ million km, $BF_1 = (1 + \epsilon)OA = 152.1$ million km.

11.3 Kepler's second law

Kepler's second law says that the radius vector from the Sun to a planet sweeps out equal areas in equal times.

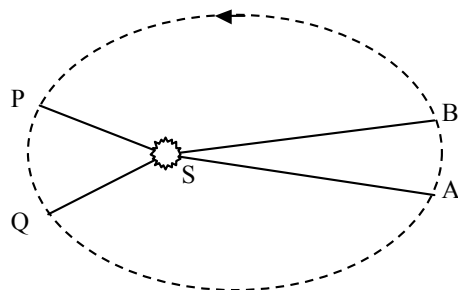
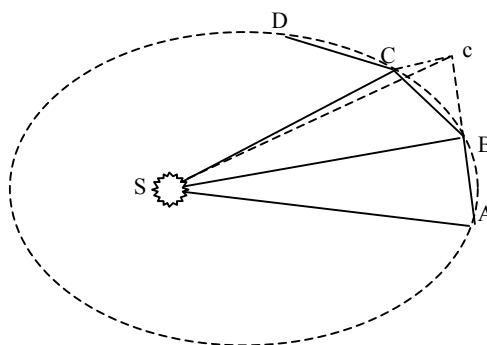

Figure 11.2: *Kepler's second law: Equal areas are swept out in equal times.*

If the planet takes equal times to move in its orbit from A to B and from P to Q, then the areas ABS and PQS are equal. Newton showed that planetary motion following Kepler's second law was consistent with motion governed by a centripetal force acting towards S. To argue this, he imagined the orbit divided into a series of small steps, AB, BC, CD and so on.



Suppose that in one unit of time the planet moves from A to B, and the effect of the centripetal force during this time is represented as acting as a single impulse at B. According to Newton's first law, the planet would, in the absence of any impulse, continue in the next interval of time to c, covering a distance $Bc = AB$. The impulse at B, however, acting along the line BS, acts to draw the orbit in to C, where cC is parallel to BS. Considering

the *areas* of triangles, $\Delta ABS = \Delta BcS$, since they have equal bases and the same height. Also $\Delta BcS = \Delta BCS$, since they have the same base and are drawn between the same parallels BS, Cc . Therefore, $\Delta ABS = \Delta BCS$, which is to say that equal areas are swept out in the two equal time steps. The same will apply to subsequent steps $CD, DE, etc.$, and also to the larger areas which may be made by summing multiple time steps to make larger intervals of time.

Example 11.2

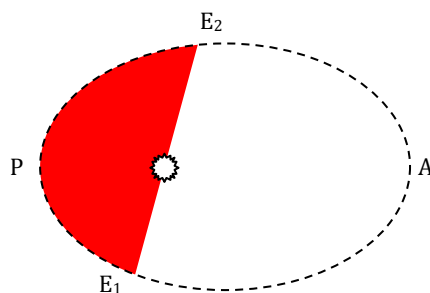

Figure 11.3: *The perihelion, P , aphelion, A , spring equinox E_1 and autumn equinox E_2 of the Earth's orbit. The shaded area (red) is clearly smaller than the unshaded area.*

In the Earth's orbit, the perihelion P (closest approach) occurs in January, the aphelion A in July, while the spring equinox E_1 (March 20 or 21) and autumn equinox E_2 (September 22 or 23) are at intermediate points as shown. Our northern hemisphere summer, measured from the spring equinox to the autumn equinox, is about seven days longer than our winter – count the days in your diary! This reflects the greater area E_1AE_2 of the ellipse, compared with E_2PE_1 .

11.4 Kepler's third law

Kepler's third law is that the squares of the orbital times of the planets – their “years” – vary as the cube of their mean distances from the Sun:

$$T^2 \propto R^3, \quad (11.1)$$

where the precise constant of proportionality is unimportant for most purposes, but can be shown to be $4\pi^2/GM$, where M is the mass of the body being orbited – the Sun in the case of planetary orbits. Here G is Newton's universal constant of gravitation; see *Section 11.5*. *Table 11.5* shows how closely Kepler's data fit.

Planet	Mean radius (a.u.)	Period (Earth years)	Radius cubed	Period squared
Mercury	0.387	0.241	0.05796	0.05808
Venus	0.723	0.615	0.3779	0.3782
Earth	1	1	1	1
Mars	1.524	1.881	3.5396	3.5382
Jupiter	5.204	11.86	140.93	140.66
Saturn	9.582	29.45	879.8	867.3

Table 11.5: *Kepler's third law.*

While Kepler's second law shows that the force governing planetary motion is directed towards the Sun, the third law tells us how it varies with distance. As we shall see, it varies according to an inverse square law.

The planetary orbits are of course elliptical, but we can get a sense of how the third law operates by looking at the special case of circular orbits. Then for a planet travelling at speed V in an orbit of radius R , with an orbital period T

$$\text{speed} = V = \frac{2\pi R}{T}$$

and

$$\begin{aligned} \text{centripetal acceleration} &= \frac{V^2}{R} \\ &= \frac{(2\pi R/T)^2}{R} \\ &= \frac{4\pi^2 R}{T^2}. \end{aligned}$$

According to the third law, the square of the time T is proportional to the cube of the distance R , so that acceleration $= 4\pi^2 R/T^2 \propto 4\pi^2 R/R^3 \propto 1/R^2$, confirming the inverse square relationship for the acceleration, and also for the force which is the product,

mass \times acceleration. In this way, the pattern of the planetary orbits in time reveals the variation of the centripetal force in space.

Example 11.3

Mars has two satellites, Phobos and Deimos, at mean distances of 9380 km and 23500 km from Mars respectively. Find the orbital period for Deimos, given that Phobos completes one revolution in 7.65 hours.

Kepler's laws do not just apply to planetary motion, but to any body orbiting any other body under the force of gravity. If T is the desired orbital time, then, by Kepler's third law, $(23500/9380)^3 = (T/7.65)^2$, hence $T = 30.3$ hours.

Example 11.4

Find the greatest distance of Halley's comet from the Sun, given that its period is 76 years and its distance of closest approach is 0.59 a.u.

From Kepler's third law, by comparison with the Earth which has $R = 1$ a.u. and $T = 1$ year, the mean distance R for Halley's comet satisfies $(R/1)^3 = (76/1)^2$, so that $R = 17.94$ a.u., giving a maximum distance of $(2 \times 17.94) - 0.59 = 35.3$ a.u., or 5280 million km.

Halley observed the comet in 1682, and found that its closest approach to the Sun was very similar to that of comets that had been seen in 1607, 1531 and 1456. From this, and the regular intervals between the sightings he concluded that these were all one and the same comet – “It would be next to a miracle if they were three different comets”. He predicted its return, therefore, in 1758. By then, he would have been 102 years old but he expressed the hope that, should the comet reappear, posterity would acknowledge that it had been first discovered by an Englishman.

11.5 Newton's law of gravitation

The well-known story is that Newton conceived the idea of universal gravitation on seeing an apple fall in his orchard, and imagining how, if unimpeded, it would continue to the centre of the Earth. Whether true or not, the story conveys the insight that the familiar, earthly force of gravity is one and the same with the force in the heavens which holds the planets to their orbits. Newton proposed then, *a power of gravity pertaining to all bodies, proportional to the quantity of matter which they contain*. Combined with the inverse square relationship with distance, this gives a formula for the gravitational attraction F of two particles A and B, with masses M and m , separated by a distance r

$$F = \frac{GMm}{r^2} . \quad (11.2)$$

In line with the third law of motion, the force F acts on both masses – if A attracts B, B attracts A. The factor G is a universal constant, the same for all masses.

Now for the test. Are the motion of the Moon and the motion of the apple in the orchard both correctly accounted for by the same value of G ? For the Moon, and its revolution around the Earth, we have as data

$$\begin{aligned} \text{distance from Moon to Earth} &= d_m = 384400 \text{ km} \\ \text{period of revolution} &= t_m = 27.32 \text{ days} = 2360 \times 10^3 \text{ secs} \\ \text{orbital speed} &= v_m = 1023 \text{ m/s} \\ \text{centripetal acceleration} &= \frac{v_m^2}{d_m} = 0.00272 \text{ m/s}^2 . \end{aligned}$$

Strictly, the Moon does not revolve around the Earth, but both revolve about their common centre of gravity. To allow for this, Newton used the adjusted value

$$\text{centripetal acceleration of Moon} = 0.00269 \text{ m/s}^2 .$$

Try this...



The sequence 2, 4, 6, 8, 10, 12, 14, 16, ... is the sequence of even whole numbers. The 100th place in this sequence is the number...?

Please click the advert

Challenging? Not challenging? Try more >>

www.alloptions.nl/life

Download free ebooks at bookboon.com

For the apple, the calculation is more complicated, which is one of the reasons for the long interval between Newton's original insight, in 1665 or 1666, and the eventual publication of his *Principia*, in 1689. The total gravitational force on the apple is the sum total of forces from all the different parts of the Earth's sphere, some of which are very close on the ground beneath, others far away at the Antipodes. These all have their own value of separation distance r in the formula for the gravitational attraction. Eventually, Newton found that the result of an exact sum over the whole sphere still agrees with the formula provided the whole mass of the Earth is treated as though located at its centre. So for the apple

$$\begin{aligned} \text{distance from apple to centre of Earth} &= \text{radius of Earth} = 6370 \text{ km} \\ \text{centripetal acceleration (observed value)} &= 9.81 \text{ m/s}^2 . \end{aligned}$$

For consistency, then, the centripetal acceleration of the Moon, adjusted according to the inverse square law for the different distances from the centre of force, should match the observed gravitational acceleration of the apple. So

$$\text{calculated acceleration} = 0.00269 \times \left(\frac{384400}{6370} \right)^2 = 9.80 \text{ m/s}^2 ,$$

which as Newton said of his own calculation, "answers pretty nearly" to the familiar value of g .

Example 11.5

To help convey the idea of how the Moon stays up, while at the same time continuously falling down, Newton offered the picture of a cannon, fired horizontally from the top of a high mountain. As the muzzle velocity increases, the range of the shot increases, until finally at some very high velocity the cannonball goes right round the Earth. It becomes a 'little moon'.

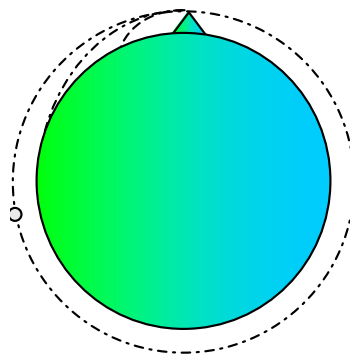

Calculate the speed with which – in the absence of air resistance – the 'little moon' would circle the Earth, and its corresponding orbital period.

If we assume that the height of the mountain is small compared with the radius of the Earth, the radius of the orbit may be approximated by the radius of the Earth, 6370 km

say, and the centripetal acceleration will simply be the value of g at the Earth's surface, $g = 9.8 \text{ m/s}^2$. If v is the speed of the 'moon',

$$\text{acceleration} = "v^2/r" = \frac{v^2}{6370 \times 1000} = g = 9.8 ,$$

so that $v = 7901 \text{ m/s}$, with an orbital period of $(2\pi \times 6370 \times 1000)/7901 = 5066$ seconds, or about 84 minutes.

A similar calculation applies to the orbits of artificial satellites, orbiting at around 250 km above the Earth. Sometimes these are visible moving rapidly across the night sky, taking 7 or 8 minutes, if passing directly overhead, to traverse from one horizon to the other.

Example 11.6

Find the ratio of the mass of the Earth to the mass of the Sun.

Denote by M_s , M_e and M_m the masses of the Sun, the Earth and the Moon, let R_e , V_e and T_e be the radius, speed and period of the Earth's orbit around the Sun, with R_m , V_m and T_m the corresponding parameters for the Moon's orbit around the Earth. For the Earth's orbit, Newton's second law says

$$\text{gravitational force} = \text{mass of earth} \times \text{acceleration of earth} ,$$

or equivalently

$$\frac{GM_s M_e}{R_e^2} = M_e \frac{V_e^2}{R_e} = \frac{M_e (2\pi R_e / T_e)^2}{R_e} .$$

After simplifying

$$GM_s = \frac{4\pi^2 R_e^3}{T_e^2} .$$

Replacing subscript e by subscript m , and subscript s by subscript e , we have the corresponding equation for the Moon's orbit

$$GM_e = \frac{4\pi^2 R_m^3}{T_m^2} .$$

Dividing the second equation by the first

$$\frac{M_e}{M_s} = \left(\frac{R_m}{R_e} \right)^3 \times \left(\frac{T_e}{T_m} \right)^2 .$$

With $R_m = 0.3844$ million km, $R_e = 149.6$ million km, $T_m = 27.32$ days, $T_e = 365.25$ days

$$\frac{M_e}{M_s} = \left(\frac{0.3844}{149.6} \right)^3 \times \left(\frac{365.25}{27.32} \right)^2 = 3.02 \times 10^{-6} .$$

Example 11.7

Given the value – determined in the laboratory – for $G = 6.673 \times 10^{-11} \text{ N m}^2/\text{kg}^2$, find the mass of the Sun.

The equation derived in *Example 11.6* for the orbit of the Earth gives

$$GM_s = \frac{4\pi^2 R_e^3}{T_e^2},$$

so that

$$M_s = \frac{4\pi^2 R_e^3}{GT_e^2}.$$

Putting in the data values from *Example 11.6*, $M_s = 1.99 \times 10^{30} \text{ kg}$. This calculation is the justification for the experimentalist's claim that the measurement of G is equivalent to “weighing the Sun”. The mass of the Earth then comes for free: $M_e = 3.02 \times 10^{-6} M_s \approx 6 \times 10^{24} \text{ kg}$.

Please click the advert

You've applied to your University...

Now Choose Your Bed!

Nido has some great options left! Live in one of our **twin studios in Nido King's Cross** or **two bedroom studios in Nido Spitalfields**.

Nido is the newest way of living student life in central London. It's not just a residence, it's a way of living that we call 'Nidology'.



Book your room and we will reward you with a £50 voucher from www.voucherepress.co.uk voucher* to spend in London shops! To enter, make a booking with Nido online using the promotional code 'Bookboon01.' For terms and conditions, please visit:

www.NidoStudentLiving.com/Bookboon

WIN a £50 Voucher with every booking!

Nido

Download free ebooks at bookboon.com

A The language of vectors

A.1 Vectors

Vector quantities are those which have a direction as well as a magnitude. The word literally means ‘carrier’, as in ‘vehicle’. Examples of vectors are velocity, acceleration, or force, by contrast with mass or temperature which are ‘scalars’ having no sense of direction involved in their definition. We have of course, already been working with these vector quantities, but pause now to re-express some of the same ideas in a vector language which did not emerge until the nineteenth century, long after the time of Galileo and Newton. The vector language says nothing fundamentally new, but it does make some of the more subtle ideas easier to express.

A.2 Displacement vectors and vector addition

The most fundamental vector is the displacement vector, a simple translation in space, such as ‘take two steps to the right’. It has magnitude, ‘two’, and direction, ‘to the right’.

Let us give the vector ‘take two steps to the right’ a name, say \mathbf{a} . (Traditionally, vectors, in typescript, are written in bold, or, underlined if written by hand. *i.e.* \mathbf{a} or \underline{a} . Alternatively, they may be written with an arrow above them \vec{a} .) In the same way ‘take one step forward’ is another vector, say \mathbf{b} . ‘Take two steps to the right and one step forward’ is an example of vector addition. We can say the combined instruction is a vector $\mathbf{c} = \mathbf{a} + \mathbf{b}$. When we come to represent this on a diagram there are several ways in which it can be done. We can draw the vectors on the page in the order that they are given. Starting at O , two steps to the right bring us to a point A . From A , one step forward takes us to the final position C .

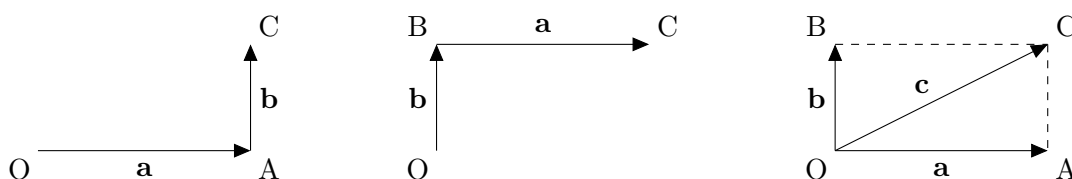

Figure A.1: *Left: \mathbf{a} followed by \mathbf{b} . Center: \mathbf{b} followed by \mathbf{a} . Right: The resultant $\mathbf{c} = \mathbf{a} + \mathbf{b}$.*

Alternatively, we can draw the steps in the reverse order. Now we go first one step forward from O to say B , and then two steps to the right to the same final position C . The vector arrow corresponding to ‘take two steps to the right’ now starts from B , instead of O , and ‘take one step forward’ starts from O instead of A . But they are still the same vectors

a and **b**. They have the same magnitude and the same direction as before. We are not obliged to draw them anchored always to the same point.

A third diagram shows the arrows for the two instructions both starting at O. Here we need to complete the rectangle OACB to find the final position C. All three diagrams express the same idea – that the two separate instructions, when combined or ‘added’ together, have the same outcome as the single instruction ‘move diagonally, one step forwards and two steps to the right’.

The same ideas apply when we add vector **e** to vector **f** when these are obliquely inclined, rather than perpendicular. OEGF then becomes a parallelogram rather than a rectangle and $\mathbf{g} = \mathbf{e} + \mathbf{f}$.

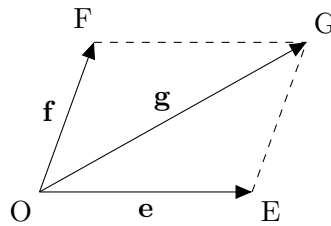

Adding **a** to itself creates the vector $2\mathbf{a} = \mathbf{a} + \mathbf{a}$. This clearly has the same direction as **a** but moves twice as far. $-\mathbf{a}$, or $-1 \times \mathbf{a}$, similarly means the vector which has the same magnitude as **a**, but is in the opposite direction, while $\frac{1}{2}\mathbf{a}$ has the same direction, but moves only half as far. Other multiples or combinations, such as $\mathbf{a} + 2\frac{3}{4}\mathbf{b}$ or $2\mathbf{a} - 3\mathbf{b}$ also have the obvious meaning.

Please click the advert

THIS **ebook** IS PRODUCED WITH **iText**®

Download free ebooks at bookboon.com

A.3 Position vectors

Position vectors are vectors which are used to describe positions. The vector \mathbf{a} is in itself a pure movement, or displacement. But if we decide to relate it to a fixed point of departure O , \mathbf{a} describes not just the movement but also the point, call it A , to which it brings us. Diagram such as those of $OACB$ or $OEGF$ above then have a dual interpretation, covering both the movements \mathbf{a} , \mathbf{b} , \mathbf{c} etc. and the geometry of the positions $A, B, C \dots$

At this point the student might reasonably ask what is the purpose of bringing in the new terminology if the end result is only to arrive at geometry which we already know? Is it only jargon? The answer seems to be that the language of vectors is much more compact. For example, the point M with position vector $\frac{1}{2}\mathbf{a} + \frac{1}{2}\mathbf{b}$ is the midpoint of AB , and the point D with position vector $\frac{1}{4}\mathbf{a} + \frac{3}{4}\mathbf{b}$ lies on AB and divides it in the ratio $AD : DB = 3 : 1$. Saying " $\frac{1}{4}\mathbf{a} + \frac{3}{4}\mathbf{b}$ " is much shorter. This helps us express more subtle or more complex statements and still keep the thread of the argument.

Example A.1

Show that if \mathbf{a} and \mathbf{b} are the position vectors of points A and B , the point with position vector $\frac{1}{2}\mathbf{a} + \frac{1}{2}\mathbf{b}$ is the midpoint of AB , and the point D with position vector $\frac{1}{4}\mathbf{a} + \frac{3}{4}\mathbf{b}$ lies on AB and divides it in the ratio $AD : DB = 3 : 1$.

First, we argue that if \mathbf{a} takes us from O to A , and \mathbf{b} takes us from O to B , then the displacement vector \mathbf{x} which would take us from A to B is $(\mathbf{b} - \mathbf{a})$. Going from O to A , and then from A to B , is the same in the end as going straight from O to B . So

$$\mathbf{a} + \mathbf{x} = \mathbf{b} ,$$

and $\mathbf{x} = \mathbf{b} - \mathbf{a}$. Going half way from A to B arrives at M , with position vector $\mathbf{m} = \mathbf{a} + \frac{1}{2}\mathbf{x} = \mathbf{a} + \frac{1}{2}(\mathbf{b} - \mathbf{a}) = \frac{1}{2}\mathbf{a} + \frac{1}{2}\mathbf{b}$, and going three quarters of the way at D , with $\mathbf{d} = \mathbf{a} + \frac{3}{4}\mathbf{x} = \mathbf{a} + \frac{3}{4}(\mathbf{b} - \mathbf{a}) = \frac{1}{4}\mathbf{a} + \frac{3}{4}\mathbf{b}$.

Example A.2

The medians of a triangle ABC are the lines joining A to the mid-point of BC , B to the midpoint of CA , C to the midpoint of AB . Show that the three medians meet at a common point G , called the centroid, which divides each median in the ratio $2 : 1$.

Suppose that the position vectors of A, B, C are $\mathbf{a}, \mathbf{b}, \mathbf{c}$. We propose that the point G is the point with position vector $\mathbf{g} = \frac{1}{3}\mathbf{a} + \frac{1}{3}\mathbf{b} + \frac{1}{3}\mathbf{c}$ and check that it satisfies the required conditions.

If D is the mid-point of BC , its position vector is $\mathbf{d} = \frac{1}{2}\mathbf{b} + \frac{1}{2}\mathbf{c}$. The vector \mathbf{y} which takes us from A to D , so that $\mathbf{d} = \mathbf{a} + \mathbf{y}$, is $\mathbf{y} = \mathbf{d} - \mathbf{a} = \frac{1}{2}\mathbf{b} + \frac{1}{2}\mathbf{c} - \mathbf{a}$. If we travel only two

thirds of the way from A to D we arrive at a point with position vector

$$\begin{aligned} \mathbf{a} + \frac{2}{3}\mathbf{y} &= \mathbf{a} + \frac{2}{3}(\mathbf{d} - \mathbf{a}) \\ &= \mathbf{a} + \frac{2}{3}\left(\frac{1}{2}\mathbf{b} + \frac{1}{2}\mathbf{c} - \mathbf{a}\right) \\ &= \frac{1}{3}\mathbf{a} + \frac{1}{3}\mathbf{b} + \frac{1}{3}\mathbf{c}, \end{aligned}$$

which is our designated point G. G therefore lies on the median through A and divides it in the required ratio 2 : 1, and by a similar argument G will lie on the medians through B and C and divide them also in the same ratio.

The compactness of the vector notation means that the same type of argument applies in three dimensions as well as in two. It would be equally easy to show that the medians of a tetrahedron, joining corners to the centroids of the opposite faces, are also concurrent. If the corners have position vectors \mathbf{a} , \mathbf{b} , \mathbf{c} , \mathbf{d} , the point where the medians intersect turns out to be $\frac{1}{4}\mathbf{a} + \frac{1}{4}\mathbf{b} + \frac{1}{4}\mathbf{c} + \frac{1}{4}\mathbf{d}$.

A.4 Vectors for velocity, momentum, acceleration, force

When the simple movement or displacement described by a vector is interpreted as the movement occurring within a given unit of time, we have a velocity vector. We are just saying velocity = displacement/time, in two or three dimensions, in place of the formula in one dimension, speed = distance/time.

Similarly, for momentum vectors. If \mathbf{v} is a velocity vector, then, as seen above, we can ascribe a meaning to $\frac{1}{2}\mathbf{v}$, or $3\mathbf{v}$, and so equally to $m\mathbf{v}$, where m is a mass.

Again, just as velocity vectors may be defined as changes in displacement vectors, within a given unit of time, so acceleration vectors are defined as changes in velocity vectors, per given unit of time. And if acceleration \mathbf{a} is a vector, so also is force \mathbf{F} , defined as $m\mathbf{a}$.

Example A.3

Ferryman F takes a passenger across a river 100 m wide. F can row at 1 m/s through the water and the river flows at a speed of 0.5 m/s. Calculate the time taken to reach the point directly opposite on the other bank.

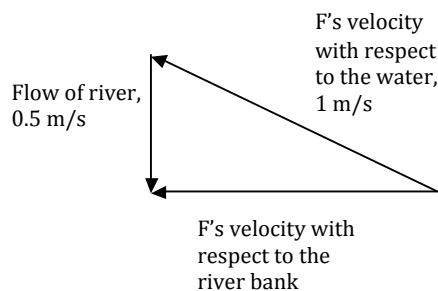

To travel directly across the river, F must aim upstream. In a vector diagram, we combine, tip to tail, arrows representing the river flow and F's motion through the water, and find the actual velocity relative to the river bank as their vector sum. If F's destination is directly across the river, we know that the actual velocity must be perpendicular to the river flow, and so can use Pythagoras' theorem to calculate his speed relative to the bank as $\sqrt{(1^2 - 0.5^2)} = \sqrt{3}/2 = 0.866$ m/s. The time taken to cover the 100 m width is $100/0.866 = 115$ seconds.

It is fundamental to calculations like this that the Pythagoras' theorem and all the other rules of geometry remain valid when applied to displacement vectors, velocity vectors or force vectors *etc.* We in fact know this to be so because of the direct correspondence between displacement vectors and position vectors, which considered as ordinary locations necessarily follow standard geometry.

Fast-track your career

Please click the advert

Masters in Management



London Business School
Regent's Park
London NW1 4SA
United Kingdom
Tel +44 (0)20 7000 7573
Email mim@london.edu
www.london.edu/mim/

Stand out from the crowd

Designed for graduates with less than one year of full-time postgraduate work experience, London Business School's Masters in Management will expand your thinking and provide you with the foundations for a successful career in business.

The programme is developed in consultation with recruiters to provide you with the key skills that top employers demand. Through 11 months of full-time study, you will gain the business knowledge and capabilities to increase your career choices and stand out from the crowd.

Applications are now open for entry in September 2011.

For more information visit www.london.edu/mim/
email mim@london.edu or call +44 (0)20 7000 7573

Example A.4

Mr E is at sea, making for an island 2 km to the west. In still conditions, he can row at 3 km/hr, but because his boat drifts in the strong north-westerly breeze it deviates from his chosen course to the extent of an additional velocity of 2 km/hr towards the south east. How long will he take to reach the island?

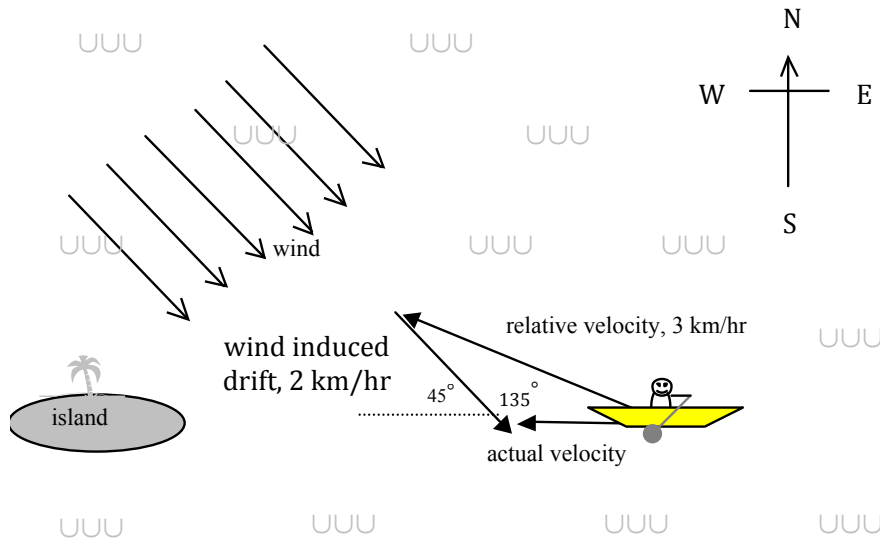

The method of solution is just the same as for the ferryman in *Example A.3* but the vector diagram for the velocities is a little more complicated in that it has no right angle. We have to use the cosine rule rather than Pythagoras' theorem. If Mr E's actual speed, relative to the island, is v , the cosine rule gives $3^2 = 2^2 + v^2 - (2 \times 2 \times v \cos(135^\circ))$. With $\cos(135^\circ) = -\cos(45^\circ) = -1/\sqrt{2}$, we find a quadratic equation for v , $v^2 + 2\sqrt{2}v - 5 = 0$, with relevant solution $v = 1.23$ km/hr. The time take to reach the island is $2/1.23 = 1.62$ hours, or 1 hour 37 minutes.

Example A.5

A kite of mass 0.5 kg is attached to a fixed point on the ground by a string and kept airborne by a lift force of 20 newtons from the wind. If the lift force is inclined at an angle of 30° to the vertical, what is the tension in the string?

We investigated a similar kite calculation in *Chapter 5* and now look again from the vector point of view. If the kite is in equilibrium, the three forces acting on it – its weight, the lift force and the tension in the string T – sum to zero. The vector arrows placed nose to tail in a vector diagram must form a closed triangle, or “triangle of forces”. See *Figure A.2*.

A practical tip in sketching the triangle is to put in the known forces first. Here, we started with the vector arrow for the weight, and then adjoined the arrow for the lift force. Then the tension force necessarily has to complete the triangle. The magnitude of

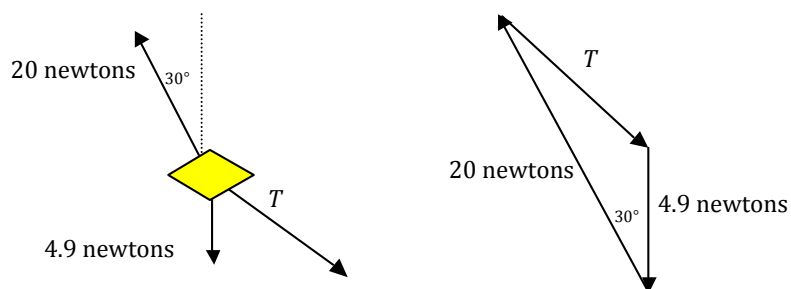

Figure A.2: *The kite of Example A.5 showing the forces acting on it (left) and the resulting triangle of forces (right).*

the tension can be calculated using the cosine rule

$$T^2 = 4.9^2 + 20^2 - (2 \times 4.9 \times 20 \cos(30^\circ)) ,$$

so that $T = 15.9$ newtons.

One may be tempted to ask where the kite is in the force diagram. The answer is that it is not there at all. The diagram is not a picture of the physical set-up but a diagram purely of the force vectors that act on the kite.

Example A.6

Snooker ball A of mass m makes an oblique impact on an identical stationary ball B. Show that under the assumption of a perfectly elastic collision the velocities of A and B after impact are at right angles.

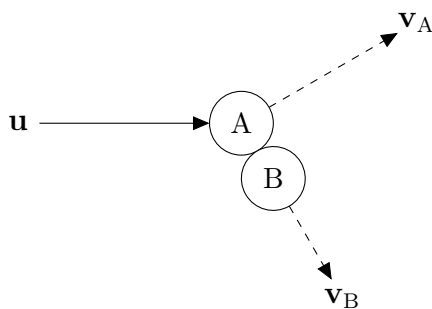

Momentum, in an oblique collision, is conserved both along the original line of motion of ball A and also in the transverse direction. Expressed in a single vector equation, the momentum conservation law becomes

$$m\mathbf{u} = m\mathbf{v}_A + m\mathbf{v}_B .$$

Cancelling the factor m ,

$$\mathbf{u} = \mathbf{v}_A + \mathbf{v}_B ,$$

which drawn in a vector diagram is:

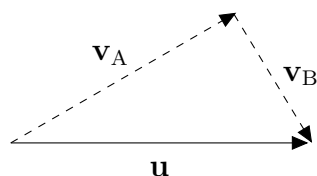

If the collision is perfectly elastic, kinetic energy is conserved, and

$$\frac{1}{2}mu^2 = \frac{1}{2}mv_A^2 + \frac{1}{2}mv_B^2 ,$$

or

$$u^2 = v_A^2 + v_B^2 ,$$

which expresses Pythagorass theorem for the triangle of velocity vectors. Here, u , v_A and v_B are the *magnitudes* of their respective velocity vectors. \mathbf{v}_A and \mathbf{v}_B , the velocities of balls A and B after impact, are therefore at right angles, giving visible expression to the principle of the conservation of energy.

A.5 Unit vectors

For practical calculations, it is often convenient to express vectors in terms of components along co-ordinate axes. If \mathbf{i} is a vector of unit length directed along the x -axis, and \mathbf{j} a vector of unit length along the y -axis, then $\mathbf{r} = a\mathbf{i} + b\mathbf{j}$ represents the displacement from the origin to (a, b) , or equally the position vector (a, b) . Velocity, acceleration or force vectors can similarly be expressed, so that for example $\mathbf{v} = c\mathbf{i} + d\mathbf{j}$ represents a velocity whose components along the x - and y -axes are c m/s and d m/s respectively.

Example A.7

Relative to a lighthouse at the origin O , a yacht Y has position vector $-8\mathbf{i} + 6\mathbf{j}$, where distances are measured in km and \mathbf{i} and \mathbf{j} are unit vectors in the directions east and north respectively. Calculate **(a)** the distance of the yacht from the lighthouse and **(b)** its bearing, as seen from the lighthouse.

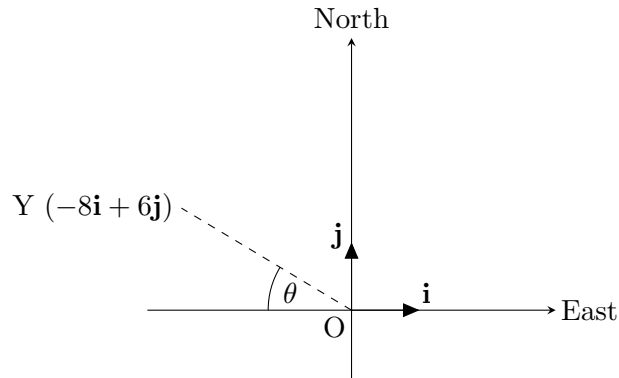

The distance of the yacht from the lighthouse, evidently, is given by Pythagoras' theorem, $OY = \sqrt{(8^2 + 6^2)} = 10$ km. The bearing of the yacht is the angle between due north and the direction OY , measured in a clockwise direction. In the diagram, θ is the angle $\arctan(6/8) = 36.9^\circ$, and the bearing is therefore $270^\circ + 37^\circ = 307^\circ$, to the nearest degree.

Example A.8

Crow C flies at a speed of 10 m/s from tree A with position vector $20\mathbf{i} + 10\mathbf{j}$ to tree B with position vector $90\mathbf{i} + 250\mathbf{j}$. (Distances are given in metres and the unit vectors \mathbf{i} and \mathbf{j} are due east and due north). Determine **(a)** the distance AB , **(b)** the time of flight, **(c)** the velocity vector for C , and **(d)** the direction of motion, expressed as a bearing.

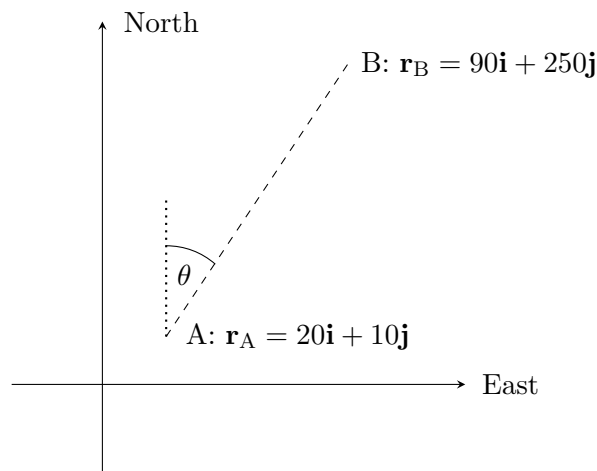

If \mathbf{r}_A and \mathbf{r}_B are the position vectors of A and B, the displacement vector \overrightarrow{AB} is $\mathbf{r}_B - \mathbf{r}_A = (90\mathbf{i} + 250\mathbf{j}) - (20\mathbf{i} + 10\mathbf{j}) = 70\mathbf{i} + 240\mathbf{j}$, and from Pythagoras the distance AB is $\sqrt{(70^2 + 240^2)} = 250$ metres. At a speed of 10 m/s, the crow will cover this distance in 25 seconds. The velocity vector is $\mathbf{v} = \text{displacement}/\text{time} = (70\mathbf{i} + 240\mathbf{j})/25 = 2.8\mathbf{i} + 9.6\mathbf{j}$ m/s, and the bearing is the angle θ in the diagram, $\theta = \arctan(70/240) = 16.3^\circ$.

Example A.9

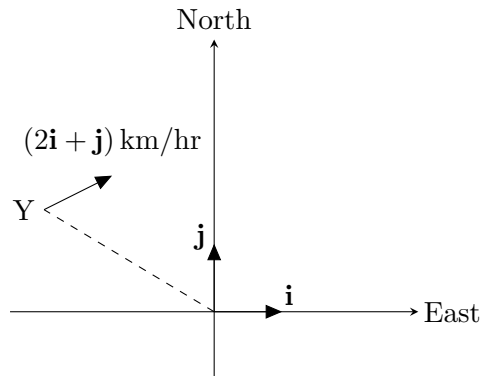

At noon, the yacht in *Example A.7* moves off with velocity vector $2\mathbf{i} + \mathbf{j}$ km/hr. Calculate (a) the time at which it will be due north of O, (b) the distance OY at its closest approach to O, and (c) the time at which this closest approach occurs.

With both the initial position and the velocity specified in terms of unit vectors, the information can be combined into a single equation for the position vector \mathbf{r}_Y at time t hours after noon. This is

$$\mathbf{r}_Y = (-8 + 2t)\mathbf{i} + (6 + t)\mathbf{j} .$$

The yacht will be due north of O when the coefficient of \mathbf{i} in the equation for \mathbf{r}_Y is zero. This occurs when $(-8 + 2t) = 0$, $t = 4$, that is at 4 pm.

The distance OY, according again to Pythagoras, satisfies

$$OY^2 = (-8 + 2t)^2 + (6 + t)^2 = 100 - 20t + 5t^2 .$$

Separating out the perfect square,

$$OY^2 = 100 - 20t + 5t^2 = 80 + 5(4 - 4t + t^2) = 80 + 5(t - 2)^2 .$$

OY will be smallest when OY^2 is smallest, and since the square term can never be less than zero, this will be when $OY^2 = 80$. The minimum distance is therefore $OY = \sqrt{80} = 8.9$ km, which occurs when $t = 2$, *i.e.* at 2 pm.

The alternative method to find the minimum value of OY^2 , for those who prefer calculus, is to equate the differential $\frac{d(OY^2)}{dt}$ to zero, giving $-20 + 10t = 0$, or $t = 2$. Then check

that the second differential is positive (so that we have a minimum value rather than a maximum) and substitute $t = 2$ back into the expression for $OY^2 = 100 - 20t + 5t^2 = 100 - (20 \times 2) + (5 \times 2^2) = 80$. $OY = \sqrt{80} = 8.9$ km, as before.

Example A.10

A ball, travelling horizontally at 7 m/s, rolls over the edge of a cliff. Relative to an origin on the edge of the cliff, what will its position vector be 2 seconds later? What will its velocity vector be?

This is an example from *Chapter 2*, now expressed in vector form. In *Chapter 2* the solution depends on separate calculations for horizontal and vertical motion, using the constant acceleration formulæ. Here, we use the same formulæ but in vector form, using the \mathbf{i} , \mathbf{j} format to distinguish between horizontal and vertical. To find the position of the ball, we use the vector form of $s = ut + \frac{1}{2}at^2$, with initial velocity $\mathbf{u} = 7\mathbf{i}$ and acceleration $\mathbf{a} = -9.8\mathbf{j}$. With $t = 2$,

$$\begin{aligned}\mathbf{s} &= x\mathbf{i} + y\mathbf{j} \\ &= \mathbf{u}t + \frac{1}{2}\mathbf{a}t^2 \\ &= (7\mathbf{i} \times 2) + \left(\frac{1}{2} \times (-9.8\mathbf{j}) \times 2^2\right) \\ &= 14\mathbf{i} - 19.6\mathbf{j} .\end{aligned}$$

Similarly, the velocity vector is given by

$$\begin{aligned}\mathbf{v} &= v_x\mathbf{i} + v_y\mathbf{j} \\ &= \mathbf{u} + \mathbf{a}t \\ &= (7\mathbf{i} - 19.6\mathbf{j}) \text{ m/s} .\end{aligned}$$

Example A.11

Snooker ball A with mass 0.15 kg and velocity vector $0.35\mathbf{i}$ m/s, strikes a glancing blow on an identical stationary ball B. After the impact, ball B is observed to have velocity vector $0.15\mathbf{i} - 0.15\mathbf{j}$ (in m/s). Use the law of conservation of momentum, in vector form, to find the new velocity vector of ball A. What are the speeds of A and B after the collision? What is the angle between their directions of motion? What proportion of the initial kinetic energy is lost in the collision?

The vector form of the law of conservation of momentum

$$m\mathbf{u}_A + m\mathbf{u}_B = m\mathbf{v}_A + m\mathbf{v}_B, \quad (\text{A.1})$$

here takes the form

$$(0.15 \times 0.35\mathbf{i}) + (0.15 \times \mathbf{0}) = (0.15 \times (x\mathbf{i} + y\mathbf{j})) + (0.15 \times (0.15\mathbf{i} - 0.15\mathbf{j})),$$

where $\mathbf{0} = 0\mathbf{i} + 0\mathbf{j}$ stands for the zero vector. Equating coefficients of \mathbf{i} and \mathbf{j} , we find $x = 0.2$, $y = 0.15$, so the velocity vector for ball A after the collision is $0.2\mathbf{i} + 0.15\mathbf{j}$ m/s and its speed is $\sqrt{(0.2^2 + 0.15^2)} = 0.25$ m/s. Its velocity now makes an angle $\arctan(0.15/0.2) = 36.9^\circ$ with its original direction of motion, parallel to the unit vector \mathbf{i} .

B has speed $\sqrt{(0.15^2 + 0.15^2)} = 0.212$ m/s and moves off at an angle of $\arctan(0.15/0.15) = 45^\circ$ so that the angle between the directions of motion of A and B is $36.9^\circ + 45^\circ = 81.9^\circ$.

The initial kinetic energy of ball A is $\frac{1}{2}mu^2 = \frac{1}{2} \times 0.15 \times 0.35^2 = 0.00919$ J. After the collision, the kinetic energy of A is $\frac{1}{2} \times 0.15 \times 0.25^2 = 0.00469$ J and the kinetic energy of B is $\frac{1}{2} \times 0.15 \times (0.15^2 + 0.15^2) = 0.00338$ J, making a total of 0.00806 J. The loss of energy is 0.00113 J, 12.2% of the initial total.

Example A.12

Mr C playing cricket, despatches a ball back over the bowler's head with velocity $18\mathbf{i} + 18\mathbf{j}$ m/s, where \mathbf{i} is a unit vector directed horizontally, along the line of the wickets, and \mathbf{j} is a unit vector in the vertical direction. The ball was bowled with velocity $-40\mathbf{i}$ and just clears the boundary 65 metres away. Given that the ball has mass 0.16 kg, calculate (a) the magnitude of the impulse imparted to the ball and (b) the impulse required if instead the ball clears the boundary (also 65 metres distant) over square leg? For those not familiar with the fielding positions of cricket, square leg lies along the line of the stumps being defended by the batsman, perpendicular to the line of the pitch.

(a) Here, we apply the definition of impulse in its vector form, $\mathbf{I} = m\mathbf{v} - m\mathbf{u}$. With initial velocity $\mathbf{u} = -40\mathbf{i}$, and final velocity $\mathbf{v} = 18\mathbf{i} + 18\mathbf{j}$, the impulse is $\mathbf{I} = 0.16(58\mathbf{i} + 18\mathbf{j})$, and has magnitude $0.16\sqrt{(58^2 + 18^2)} = 0.16 \times 60.73 = 9.7$ N s.

(b) If the ball goes over the square leg boundary, a three dimensional calculation is required and we introduce a third unit vector \mathbf{k} , perpendicular to both \mathbf{i} and \mathbf{j} , in the horizontal direction from Mr C at the wicket towards square leg. The final velocity of the ball is $18\mathbf{j}+18\mathbf{k}$ and the impulse $\mathbf{I} = m\mathbf{v} - m\mathbf{u}$ is $\mathbf{I} = 0.16(40\mathbf{i} + 18\mathbf{j} + 18\mathbf{k})$. Applying Pythagoras in its three dimensional form, the impulse has magnitude $0.16\sqrt{(40^2 + 18^2 + 18^2)} = 0.16 \times 47.41 = 7.6 \text{ N s}$.

Please click the advert



You're full of *energy*
and *ideas*. And that's
just what we are looking for.

Looking for a career where your ideas could really make a difference? UBS's Graduate Programme and internships are a chance for you to experience for yourself what it's like to be part of a global team that rewards your input and believes in succeeding together.

Wherever you are in your academic career, make your future a part of ours by visiting www.ubs.com/graduates.

www.ubs.com/graduates



© UBS 2010. All rights reserved.